



# Operator's Manual

**CENTURION**  
*WORLD CHAMPIONSHIP TOWBOATS*

# TABLE OF CONTENTS

<b>Introduction</b> .....	1-1
Congratulations .....	1-1
About This Manual .....	1-2
About Your New Boat.....	1-3
<b>Warranty</b> .....	2-1
Warranty.....	2-1
<b>Safety</b> .....	3-1
General Safety .....	3-2
Good Boating Practices .....	3-2
Safety Decals and Statements .....	3-4
Carbon Monoxide.....	3-13
Required Boating Safety Equipment and Regulations .....	3-14
Recommended Safety Equipment.....	3-21
Water Sports Safety .....	3-22
<b>Boating Regulations &amp; Your Responsibilities</b> .....	4-1
Boat Owner / Operator Responsibilities .....	4-1
Safety .....	4-2
Registration .....	4-2
Insurance .....	4-2
Reporting Accidents .....	4-2
Boating Under the Influence.....	4-3
Operator's License and Education .....	4-3
Operation by Minors.....	4-3
Emergency Assistance.....	4-4
Protecting the Environment.....	4-4
Foreign Species Transportation .....	4-4
Noise .....	4-4
Speed.....	4-4
Wake .....	4-4
Pollution Regulations .....	4-5
<b>Emergencies</b> .....	5-1
First Aid / Medical Emergencies.....	5-1
Emergency Preparation Checklist.....	5-1
Carbon Monoxide Poisoning.....	5-1
Fire and Explosion .....	5-2
Using Distress Signal Devices and Calling for Help.....	5-3
Capsizing and Flooding.....	5-4



Man Overboard.....	5-4
Running Aground .....	5-5
Dangerous Weather .....	5-6
Engine or Boat System Failure.....	5-6
Accidents, Collisions and Giving Assistance.....	5-6
Towing on the Water .....	5-6
<b>Operating in Hazardous Conditions .....</b>	<b>6-1</b>
Severe Weather.....	6-1
Water Hazards.....	6-2
Restricted Areas.....	6-3
Markers, Warnings and Advisories.....	6-4
<b>Navigation Rules and Aids .....</b>	<b>7-1</b>
Audible Distress Signals.....	7-1
Right-of-Way.....	7-2
Navigational Lights & Night Operation.....	7-2
Speed .....	7-3
Wake .....	7-3
Overtaking / Passing .....	7-3
Meeting Head-On .....	7-4
Crossing .....	7-5
Aids to Navigation.....	7-6
<b>Operating Your Boat.....</b>	<b>8-1</b>
Safety Precautions .....	8-1
Before Getting Under Way .....	8-1
Getting Under Way .....	8-6
<b>Trailering and Launching.....</b>	<b>9-1</b>
Legal Considerations.....	9-1
Trailer Type .....	9-1
Trailer Classification .....	9-1
Trailer Gross Vehicle Weight Rating .....	9-2
Vehicle Towing Hitch.....	9-2
Hitch Ball and Trailer Coupler.....	9-3
Safety Chains .....	9-4
Towing Vehicle .....	9-4
Trailer Brakes .....	9-5
Trailering Guidelines.....	9-6
Launching.....	9-8
Loading Guidelines.....	9-9
<b>Boat Features and Options.....</b>	<b>10-1</b>
Steering System .....	10-1
Shift and Throttle Controls.....	10-4
Gauges / Instruments .....	10-6
Helm and Control Switches .....	10-13

Fuel System .....	10-18
Engine Cooling System .....	10-18
Engine Exhaust System .....	10-19
Engine Lubrication System.....	10-19
Electrical System.....	10-19
Bilge Pump System.....	10-20
Ballast Tank System (Optional).....	10-21
Propeller Shaft Dripless Packing.....	10-22
Propeller Strut .....	10-23
Propeller.....	10-24
Engine Compartment Ventilation System.....	10-26
Trim Tab (Optional) .....	10-26
Switch Blade (Optional).....	10-28
Wake Tower (Optional) .....	10-28
Ski Tow Pylon .....	10-29
Cockpit Heater System (Optional).....	10-29
<b>General Care and Maintenance .....</b>	<b>11-1</b>
20-Hour Inspection .....	11-1
Periodic Maintenance.....	11-2
Engine .....	11-2
Fuel System .....	11-2
V-Drive .....	11-3
Steering System.....	11-3
Propeller Shaft Dripless Packing.....	11-4
Electrical System.....	11-4
Corrosion Protection.....	11-8
General Maintenance and Cleaning.....	11-10
Safety Equipment.....	11-13
General Boating Equipment .....	11-14
Trailer .....	11-14
<b>Winterization and Storage .....</b>	<b>12-1</b>
Winterization and Storage Preparation .....	12-1
Storing on a Cradle or Blocks.....	12-2
Storing on a Trailer.....	12-3
Recommissioning After Storage.....	12-3
Lifting.....	12-5
<b>Troubleshooting .....</b>	<b>13-1</b>
<b>Glossary of Nautical Terms .....</b>	<b>14-1</b>



**This Page Intentionally Left Blank**



## *Section 1*

# **INTRODUCTION**

## **CONGRATULATIONS**

You have just become a member of the Centurion family of water sports boat owners. This manual contains recommended maintenance procedures to be used in the care of your new boat. It is important that you read this information and familiarize yourself with all the boat systems prior to operating or hauling your new Centurion boat.

First read the warranty and disclaimer enclosed, then make sure your warranty activation card has been sent to Fineline Industries to activate your warranty. If you have any questions after reading this manual, please contact your local authorized Centurion dealer.

Our mission at Centurion Boats is to continually strive to build the finest product in the market place. We have set our standards high and would like you, our customer, to know that we build pride into every boat model manufactured here at Centurion Boats. One hundred percent customer satisfaction is the goal we strive to achieve daily.

## ABOUT THIS MANUAL

Please keep this *Operator's Manual* on-board for future reference and pass it along to the new owner if you ever decide to sell the boat.

This manual has been written as a general guide to safe operating practices, boating regulations and maintenance techniques for recreational boating.

This manual is not intended to be used as a replacement for specific information and procedures covered in manuals provided by the manufacturer of the engine, trailer and other major equipment.

Suppliers of some of the major components in your boat provide care and operation information that has been included with your boat in your *Owner's Information Kit*. Read the information in this manual and the information in the *Owner's Information Kit* completely before operating your boat or any equipment.



CNTRN-0035C-A

**Figure 1-1**

Because we are constantly working toward product improvement, this manual is intended to be a general guide only. The illustrations used in this manual may not exactly match the equipment on your boat; they are intended only as general reference views.

If this is your first time owning or operating a boat, it is recommended that you contact your dealer or local boating agency to find out how to enroll in a boater safety course prior to operating the boat.

## ABOUT YOUR NEW BOAT

### Boat Terminology

You should understand, learn and use appropriate and common nautical terminology while boating to ensure your safety and the safety of others. See *Glossary of Nautical Terms on page 14-1* for additional boating terminology.

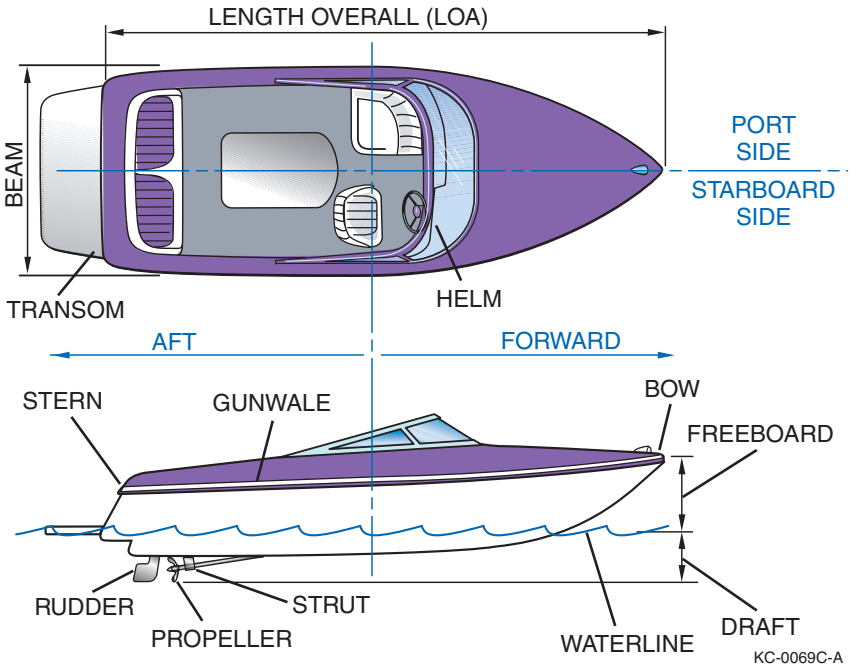

Figure 1-2

### Construction and Features

Building a Centurion boat means using the most advanced technology to produce world-championship watercraft. Features include top-performing, hydrodynamic hulls, as well as innovations like snap-out carpets, accessible coolers and gelcoat graphics.

Construction begins outside-in, with our Integrated Composite System (ICS). ICS is a 100% composite design that makes each Centurion boat strong and uses a three-piece construction process — hull, inner liner and deck. During construction, gelcoat colors and full-contour graphics are sprayed into the molds, which ensure that Centurion ski and wakeboard boat accents and graphics last all the way to the horizon.



# Section 1

After the gelcoat and fiberglass are applied and dried, giving the three ICS components solid form, the deck, hull and liner are removed from their molds and placed together. First, the inner liner is placed into the hull and bonded using a material called Plexus<sup>®</sup>, which fuses fiberglass, creating an unbreakable seal. The inner liner is then injected with flotation foam to reduce noise and vibration, and the injection points are sealed with additional fiberglass, ensuring there is no exposure to water while your boat is under way.

Electrical wiring, gas tanks and underwater gear components are installed before the final ICS pieces are added. The deck is then placed in the hull using a "Reverse Shoebox" method, which reduces the influx of water into the boat through the rub rail and creates the strongest bond possible. Plexus is applied to the hull and deck and then tightened together using stainless steel screws, allowing the Plexus to take effect.

Final assembly is made with the installation of a Mercruiser<sup>®</sup> engine, final drive system components and interior boat features. When assembly is completed the boat is lake-tested and detailed.

Centurion Boats is dedicated to revolutionizing towboat performance. In our testing and development facilities we work passionately on the water to develop new ways to push Centurion Boats ahead of the pack. Visit us at: [www.centurionboats.com](http://www.centurionboats.com)

So, whether you're just cruising on one of our boats or seriously competing behind one, here are a few Centurion innovations that will help you carve the waves (Features not available on all models):

- **Sideswipe Exhaust (patented)**  
A system that vents exhaust to either side of the boat away from the rider/surfer, with just a flick of a switch on the main console. When you need to pick up the pace for a little wakeboarding, flip the switch and it vents from both sides.
- **Vented Tracking Fins (VTF) (patented)**  
Vented Tracking Fins release the pressure built up by the water on the tracking fins of the boat, resulting in reduced vibration and noise while turning.
- **Integrated Composite System (ICS) Construction**  
Integrated Composite System is composed of a three-piece process that combines hull, inner liner and deck, which results in 100% composite designs that are strong and light.
- **Snap-Out Carpet**  
Convenient, 40 oz. marine-grade carpet that simply snaps out of the boat for easy cleaning and storage.
- **Gelcoat Graphics**  
Most graphics and colors are generated by a computer-rendered graphic system and are applied into the gelcoat. Centurion Boats stand alone when it comes to gelcoat graphics.

## Hull Identification, Capacity and Safety Plates

### Hull Identification Number

The hull identification number is located on the upper right-hand side of the transom just below the rub rail.

The HIN must be clearly visible and may not be removed, altered or tampered with in any way as regulated by federal law.

In case of collision, theft or damage, report these numbers to the local authorities, your insurance agent and your dealer. Safeguard information about your boat by recording the HIN and model of your boat and model and serial numbers of the engine, trailer and accessories on the *Boat Information Form on page 1-9*.



CNTRN-0006C-A

**Figure 1-3**

## Capacity Plate

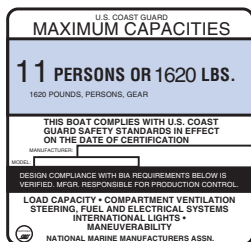

All mono-hull recreational boats less than 20 feet (6 meters) require a gross weight and person-capacity plate to be clearly displayed as provided by the manufacturer.

Boats in the National Marine Manufacturers Association (NMMA) program up to 26 feet (7.9 meters) have a maximum rated load capacity, which is stated on the certification plate (if equipped).

The person/load capacity is determined by the USCG. The capacity plate is usually located within clear visibility of the boat operator or helm area. The capacity plate indicates limits for loading the boat, which are enforceable by law. Never exceed the “U.S. Coast Guard Maximum Capacities” indicated on the capacity plate.

## U.S. Coast Guard Safety Standards Compliance Plate

All power boats less than 20 feet (6 meters) must have a manufacturer's compliance plate clearly indicating that the boat is in compliance with the USCG safety standards and the effective date of the compliance. The compliance plate may be combined onto one plate showing both the capacity plate and compliance information by the manufacturer.

## References and Contact Information

Use the following list of publications and organizations for reference and contact information concerning safe boating, navigational rules and other boating topics.

### Publications

- United States Coast Guard Auxiliary, *Boating Skills and Seamanship Thirteenth Edition*. United States Coast Guard
- Damford, Don. *Anchoring*. Seven Seas
- Bottomley, Tom. *Boatman's Handbook*. Hearst Marine Book. Morrow
- Whiting, John and Bottomley, Tom. *Chapman's Log and Owner's Manual*. Hearst Marine Book
- Chapman, Charles F. and Maloney, E.S., *Chapman's Piloting, Seamanship and Small Boat Handling*. Hearst Marine Book. Morrow
- Brotherton, Miner. *Twelve Volt Bible*. Seven Seas
- Strahm, Virgil. *Does Your Fiberglass Boat Need Repair?* Strahm
- National Fire Protection Association. *Fire Protection Standard for Pleasure and Commercial Motor Craft*. National Fire Protection Association

- United States Coast Guard. *Navigational Rules for U.S. Waterways*. United States Coast Guard. Visit <http://www.navcen.uscg.gov/mwv/NavRules> to view or download this publication.

## Organizations

### ***American Red Cross***

<http://www.redcross.org> or consult your local telephone directory

### ***National Oceanic and Atmospheric Administration's National Weather Service***

<http://www.nws.noaa.gov>

### ***U.S. Coast Guard***

<http://www.uscg.org> (To contact the U.S. Coast Guard for an emergency while on the water, you should always use your on-board VHF-FM radio Channel 16. Cell phones should only be used as a secondary means of communication. Call 9-1-1 to reach rescue personnel.)

### ***U.S. Coast Guard Office of Boating Safety***

<http://www.uscgboating.org>

### ***U.S. Coast Guard Navigation Center (NAVCEN)***

<http://www.navcen.uscg.gov>

### ***U.S. Coast Guard's America's Waterway Watch Program***

(A program for recreational boaters to assist the U.S. Department of Homeland Security in reporting suspicious activity on U.S. waterways)

Phone: 877-24-WATCH (877-249-2824)

### ***U.S. Coast Guard Pollution Control National Response Center***

Phone: 800-424-8802

### ***U.S. Power Squadrons***

<http://www.usps.org> Phone: 888-367-8777

### ***U.S. Coast Guard Auxiliary***

<http://nws.cgaux.org> Phone: 877-875-6296

### ***U.S. Coast Guard Auxiliary – Float Plan Information***

<http://www.floatplan.uscgaux.info>

### ***Boat Owner Association of the United States***

<http://www.boatus.com/>

### ***Boat U.S. Foundation for Boating Safety Hotline***

<http://www.boatus.org/onlinecourse>

Phone: 800-336-BOAT (In Virginia call 800-245-BOAT)

# Section 1

## **U.S. Government Printing Office**

(For information and documentation on FCC rules and regulations and Skippers Course information, and other government, marine and nautical related documents) <http://www.gpoaccess.gov>

## **National Association of State Boating Law Administrators**

<http://www.nasbla.org>

## **National Safe Boating Council Inc.**

<http://www.safeboatingcouncil.org>

## **National Marine Manufacturers Association**

<http://www.nmma.org>

## **American Boat & Yacht Council**

<http://abycinc.org>

## **Sea Tow Services International, Inc.**

<http://www.seatow.com> Phone: 631-765-3660 Fax: 631-765-5802  
Toll free: 800-4SEATOW (800-473-2869)

## **International Water Ski Federation**

<http://www.iwsf.com>

## **USA Water Ski**

<http://www.usawaterski.org>

## **World Wakeboard Association**

<http://www.thewwa.com>

## **INT League (International Water Sports Organization)**

<http://www.intleague.com>

## **Water Sports Industry Association**

<http://www.wsia.net>

## Boat Information Form

BOAT	
Boat Model:	Hull ID Number (HIN):
Hull Colors:	
Weight:	Registration Number:
Length:	Registration State:
Draft:	Purchase Date:
Beam:	Delivery Date:
Vertical Clearance:	Warranty Expiration Date:
Dealer:	Boat Manufacturer:
Dealer Representative:	Manufacturer Representative:
Dealer Phone:	Manufacturer Phone:
ENGINE, DRIVE and PROPELLER	
Engine:	Model Number:
	Serial Number:
Drive:	Model Number:
	Serial Number:
Propeller:	Make:
	Type:
	Size:
	Material:
	Part Number:
ACCESSORIES	
Fuel Tank Capacity:	Battery Make:
Fuel Filter Part Number:	Battery Size:
Ignition Key Number:	
TRAILER	
Trailer	Model Number:
	Serial Number:
	GVWR:
	Tire Size:

**This Page Intentionally Left Blank**



Section 2  
**WARRANTY**

**WARRANTY**

<b>Component</b>	<b>Warranty</b>
Deck/Hull/Stringer	Limited Lifetime
Engine/Drive Train	See engine and drive train warranty information.
Components	1-5 years depending on component
Instrumentation	Lifetime warranty from Faria
Upholstery/Vinyl	3 year warranty from Syntec
Carpet	3 year warranty from Syntec
Labor	1 year

**Limited Lifetime Warranty**

For this warranty to become active, the warranty card must be completed and postmarked for return to Finline Industries within 72 hours of the original purchase date.

There are no express or implied warranties on products manufactured or sold by Finline Industries, Inc. except as set forth in this limited warranty agreement.

Except as excluded or limited in this warranty, Finline Industries Inc. of 2047 Grogan Ave., Merced, CA, 95341 or Finline Industries East Inc. at P.O. Box C, Woodland, NC, 27897, warrants to the first owner (and subsequent owners eligible for and purchasing transferable warranty) that the Centurion boat is free from defects in materials and workmanship under normal use and when operated and maintained according to instructions for the term set forth as follows and in owner's manual for a period of 12 months from the date of purchase on all covered components other than the deck and the hull.

Each deck and hull are warranted to the active warranty holder for as long as the boat is owned by the active warranty holder.



### **Fineline Obligations:**

Fineline will repair or replace, at its sole option, any part covered under this warranty which is returned by the owner during the warranty period to Fineline factory or to any other authorized repair facility and which, upon Fineline's examination, discloses to Fineline's satisfaction defect at the time of delivery to the owner. In case of such a defect, Fineline will fulfill its obligation to repair or replace the defective item within 90 days of the receipt of the defective part at its factory or any Fineline authorized repair facility. Replacements will be warranted only for the remainder of the original warranty period. The repair or replacement of defective parts under warranty will be made by Fineline without charge to the owner for parts or labor. Transportation of the boat or parts to the authorized Fineline facility or Fineline factory shall be borne by the owner and return transportation charges shall be prepaid by the owner.

The replacement or repair of the defective part, as stated in this Warranty, shall be the sole remedy of the purchaser and the sole liability of the dealer and the company under the warranty and any implied warranties.

### **Warranty Exclusions**

The following are specifically excluded from coverage under this warranty:

- Anyone other than the original owner and subsequent owners eligible for, and purchasing transferable warranty.
- Paints, varnishes, gelcoat surfaces and colors, finish distortions, chrome-plated or anodized finishes, floor covers and any other surface coatings.
- Speeds, fuel consumption and other performance characteristics because they are estimated and they may vary.
- Any damage or repair required because of misuse, negligence, accident, collision, or impact with any object, or any improper alteration or repair.
- Any boat used for speed, competition or performance demonstration.
- The warranty on the deck, hull, flooring and stringers does not include hardware or other components fastened or adhered to the hull, deck, flooring or stringers.
- Gelcoat damage, such as crazing caused by impact, weathering, fading or by improper maintenance.
- Gelcoat discoloration, blisters, bubbles or cracks.
- Gelcoat blistering caused by adverse water chemistry or leaving the boat in the water for prolonged periods.
- All component parts and accessories not manufactured by Fineline including but not limited to engines, gear trains, drive trains, transmissions, propellers, shift and throttle control levers and cables, pumps, blowers, windshields, canvas, upholstery, batteries, instrumentation and steering systems. However, where any such items are warranted by a component manufacturer, Fineline will, if possible, furnish the warranty document to the owner.
- The installation of any equipment by a dealer or any other installer.

- Any boat which is: (a) used for rental or other commercial, military or industrial purposes, (b) used in boat racing, demonstrations or similar events, (c) altered, modified, repaired or replaced to increase the cubic inch capacity of horsepower output of the engine and boat as originally manufactured.
- The company reserves the right to improve its products through changes in design or material without obligation to incorporate such changes in products of prior manufacture.

## Other Warranty Limitations

- This warranty limits the duration of any implied warranty of merchantability or implied warranty of fitness for a period of 12 months from the date of purchase. Some states do not allow limitations on how long an implied warranty lasts, so this limitation may not apply to you.
- The remedies of repair or replacement at our option, as set forth above, are the only remedies under this warranty. Fineline disclaims any obligation or liabilities for loss or use of product warranted. Loss of time, inconvenience, commercial loss or any other direct, consequential, special, or incidental or consequential damages to the above limitations may not apply to you.
- This warranty is in place of any other express warranties.
- This warranty gives you specific legal rights, and you may also have other rights, which may vary from state to state.
- This warranty is expressly in lieu of any non-contractual liabilities, including product liabilities.
- The dealer is not the agent of Fineline. The company does not authorize the dealer, or any other person, to assume for the company any liability in connection herewith or any liability or expense incurred in the repairing of its products other than those expressly authorized in this limited warranty. The dealer may not extend, or in any way change or amend, this express warranty.

### **Transferable Limited Lifetime Warranty**

The Limited Lifetime Warranty Policy may be transferred (for a minimal fee) to the second purchaser during a period of 5 years from the date of delivery to the original retail purchaser.

Transferable warranty is subject to the following limitations:

- Original owner's warranty card must be on file and active according to the original agreement.
- Transferable warranty is subject to the same limitations of the original warranty.

### **Fineline Obligations:**

Fineline will repair or replace, at its sole option, any part covered under this warranty which is returned by the owner during the warranty period to Fineline factory or to any other authorized repair facility and which, upon Fineline's examination, discloses to Fineline's satisfaction defect at the time of delivery to the owner. In case of such a defect, Fineline will fulfill its obligation to repair or replace the defective item within 90 days of the receipt of the defective part at its factory or any Fineline authorized repair facility. Replacements will be warranted only for the remainder of the original warranty period. The repair or replacement of defective parts under warranty will be made by Fineline without charge to the owner for parts or labor. Transportation of the boat or parts to the authorized Fineline facility or Fineline factory shall be borne by the owner and return transportation charges shall be prepaid by the owner.

The replacement or repair of the defective part as stated in this Warranty shall be the sole remedy of the purchaser and the sole liability of the dealer and the company under the warranty and any implied warranties.

### **Transferable warranty is subject to the following limitations:**

- Original owner's warranty card must be on file and active according to the original agreement.
- Boat must be inspected by an authorized dealer or marine surveyor for any damage that may have occurred after delivery to the original owner.

### **Warranty Exclusions**

The following are specifically excluded from coverage under this warranty:

- Anyone other than the original owner and subsequent owners eligible for, and purchasing transferable warranty.
- Paints, varnishes, gelcoat surfaces and colors, finish distortions, chrome-plated or anodized finishes, floor covers and any other surface coatings.
- Speeds, fuel consumption and other performance characteristics because they are estimated and they may vary.

- Any damage or repair required because of misuse, negligence, accident, collision, or impact with any object, or any improper alteration or repair.
- Any boat used for speed, competition or performance demonstration.
- The warranty on the deck, hull, flooring and stringers does not include hardware or other components fastened or adhered to the hull, deck, flooring or stringers.
- Gelcoat damage, such as crazing caused by impact, weathering, fading or by improper maintenance.
- Gelcoat discoloration, blisters, bubbles or cracks.
- Gelcoat blistering caused by adverse water chemistry or leaving the boat in the water for prolonged periods.
- All component parts and accessories not manufactured by Fineline including but not limited to engines, gear trains, drive trains, transmissions, propellers, shift and throttle control levers and cables, pumps, blowers, windshields, canvas, upholstery, batteries, instrumentation and steering systems. However, where any such items are warranted by a component manufacturer, Fineline will, if possible, furnish the warranty document to the owner.
- The installation of any equipment by a dealer or any other installer.
- Any boat which is: (a) used for rental or other commercial, military or industrial purposes, (b) used in boat racing, demonstrations, or similar events, (c) altered, modified, repaired or replaced so as to increase the cubic inch capacity of horsepower output of the engine and boat as originally manufactured.
- The company reserves the right to improve its products through changes in design or material without obligation to incorporate such changes in products of prior manufacture.

## Other Warranty Limitations

- This warranty limits the duration of any implied warranty of merchantability or implied warranty of fitness for a period of 12 months from the date of purchase. Some states do not allow limitations on how long an implied warranty lasts, so this limitation may not apply to you.
- The remedies of repair or replacement at our option, as set forth above, are the only remedies under this warranty. Fineline disclaims any obligation or liabilities for loss or use of product warranted. Loss of time, inconvenience, commercial loss or any other direct, consequential, special, or incidental or consequential damages to the above limitations may not apply to you.
- This warranty is in place of any other express warranties.
- This warranty gives you specific legal rights, and you may also have other rights, which may vary from state to state.
- This warranty is expressly in lieu of any non-contractual liabilities, including product liabilities.

## Section 2

- The dealer is not the agent of Finline. The company does not authorize the dealer, or any other person, to assume for the company any liability in connection herewith or any liability or expense incurred in the repairing of its products other than those expressly authorized in this limited warranty. The dealer may not extend, or in any way change or amend, this express warranty.

### Warranty Service

#### **Boats with hull identification numbers (HIN) starting with “FIN” contact Centurion customer service:**

Finline Industries West  
2047 Grogan Avenue  
Merced, CA 95341  
Phone: 209-384-0255

E-mail: [sbuchner@finlineind.com](mailto:sbuchner@finlineind.com)

#### **Boats with hull identification numbers (HIN) starting with “FNE” contact Centurion customer service:**

Finline Industries East  
P.O. Box C  
Woodland, NC 27897  
Phone: 252-587-0405

E-mail: [customerservice@filineeast.com](mailto:customerservice@filineeast.com)

### Centurion Boats Internet

Visit us at: [www.centurionboats.com](http://www.centurionboats.com)



*Section 3*  
**SAFETY**

Safety is the number-one priority for Centurion Boats. Every Centurion boat is built to meet all applicable safety standards for water sports use; however, built-in safety mechanisms are never a substitute for good judgment. As a boat operator, you always take the responsibility upon yourself to operate your boat in a safe manner. Centurion continually strives to provide you with the best technology and information to keep you safe. If you ever have any safety-related questions, suggestions or concerns, please contact us directly.

**Fineline Industries West**

2047 Grogan Avenue  
Merced, CA 95341  
Phone: 209-384-0255

**Fineline Industries East**

P.O. Box C  
Woodland, NC 27897  
Phone: 252-587-0405

# GENERAL SAFETY

The popularity of boating and other water sports has undergone an explosion of growth in the past few years, making safety an important issue for everyone who shares in the use of our waterways.

**WARNING! Read and understand this Operator's Manual, the Engine Operator's Manual and all manufacturers' supplied information regarding the operation of equipment. As a boat owner you should understand all safety information responsibilities, regulations, controls and operating instructions before attempting to operate the boat. Improper operation can be extremely dangerous and/or fatal.**

The safety content and precautions listed in this manual and on the boat are not all-inclusive. If a procedure, method, tool or part is not specifically recommended, you must feel confident that it is safe for you and others, and that the boat will not be damaged or become unsafe as a result of your decision. REMEMBER – ALWAYS USE COMMON SENSE WHEN BOATING!

As a boat owner, you are responsible for your own safety, as well as that of your passengers and other boaters.

## GOOD BOATING PRACTICES

Boating-related accidents are generally caused by the operator's failure to follow basic safety rules or written precautions. Most accidents can be avoided if the operator is completely familiar with the boat and its operation and can recognize potentially hazardous situations.

In addition to everyday safety, failure to observe safety recommendations may result in severe personal injury or death to you or to others. Use caution and common sense when operating your boat. Do not take unnecessary chances! Failure to adhere to these warnings may result in severe injury or death to you and/or others.

Read this entire manual and be aware of other specific safety guidelines not listed below. Seek additional safety information from the USCG, state and local authorities. In addition to specific safety statements noted in this manual, a general list of safety guidelines and recommendations is listed below:

- Your boat must comply with USCG safety equipment regulations.
- Before each outing, check all safety equipment such as fire extinguishers, life jackets, flares, distress flags, flashlights and engine stop switch. They should be operable, in good condition, readily visible and easily accessed.
- On-board equipment must always conform to the governing federal, state and local regulations.
- Never allow any type of spark or open flame on-board. It may result in fire or explosion.

- Take the keys with you when you leave the boat to keep untrained and unauthorized persons from operating the boat.
- You should know how to react correctly to adverse weather conditions, have good navigation skills and follow the navigational rules as defined by USCG, state and local regulations.
- Check local weather reports before casting off. Do not leave the dock area when strong winds and electrical storms are in the area or predicted to be in the area.
- Seek shelter from open water if lightning is an imminent threat.
- Tell someone of your travel plans before departing.
- Know the weight capacity of your boat. Never overload your boat.
- Never operate the boat while under the influence of drugs or alcohol.
- Look before you turn the boat. As a boater you are obligated to maintain a course and speed unless it is safe to alter course and speed. Look before you turn.
- Operators must read and understand all operating manuals supplied with the boat before operation.
- Whenever you are going for an outing, make sure that at least one passenger is familiar with the operation and safety aspects of the boat in case of an emergency.
- Passengers should never sit in front of the operator; always avoid obstructing the operator's view.
- Show all passengers the location of emergency equipment and explain how to use it.
- Never allow passengers to drag their feet or hands in the water, or sit on the bow, deck or gunwale while the engine is running.
- Never use or hold onto the boarding platform while the engine is running.
- Never stand or allow passengers to stand in the boat or sit on the transom, seat backs, engine cover or sides of the boat while the engine is running. You or others may be thrown from the boat.
- Children and nonswimmers should wear a life jacket at all times.
- Never leave children in the boat without adult supervision.
- Improper operation of the boat is extremely dangerous.
- Securely attach the engine emergency stop switch lanyard to a part of your clothing, such as a belt loop, when operating the boat.
- Operate slowly in congested areas such as marinas and mooring areas.
- The bow may be slippery. Do not go forward while the engine is running.
- Slow down when crossing waves or a wake in order to minimize the impact on the passengers and the boat.
- Never dive from the boat without being absolutely sure of the depth of the water; severe injury or death may occur from striking the bottom or submerged objects.
- Never swim near the boat when the engine is running. Even if the boat is in the NEUTRAL position, the propeller may still be turning and carbon monoxide may be present.



- Watch for other boats, swimmers and obstructions in the water. Stay away from other boats and personal watercraft.
- Never replace your boat's marine parts with automotive parts (if applicable).
- Never remove or modify any components of the fuel system. Always have qualified personnel perform fuel system maintenance. Tampering with fuel components may cause a hazardous condition.
- Avoid contact with engine exhaust gases.
- Engine exhaust contains carbon monoxide.
- Never operate the engine in a confined space.
- Never go under the boat cover with the engine running or shortly after the engine has been running.
- Allow adequate ventilation with fresh air before entering any enclosed areas.

## SAFETY DECALS AND STATEMENTS

### Safety Decals

Your boat is affixed with various hazard and safety decals at the time of manufacture. These decals appear in specific locations on the boat and on equipment where safety is of particular concern. Hazard and safety decals must remain legible. If you suspect a decal is missing or one becomes damaged, contact your dealer for immediate replacement.

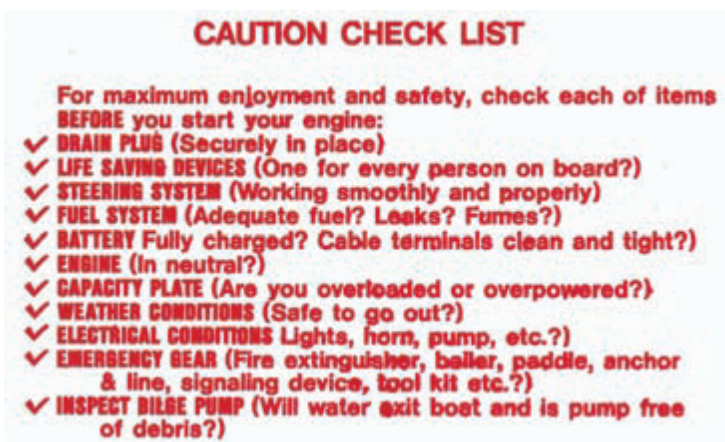

CNTRN-0050B-A

Figure 3-1

<b>⚠ DANGER</b>	
	<p>Carbon monoxide (CO) can cause brain damage or death.</p> <p>Engine and generator exhaust contains odorless and colorless carbon monoxide gas.</p> <p>Carbon monoxide will be around the back of the boat when engines or generators are running.</p> <p>Move to fresh air, if you feel nausea, headache, dizziness, or drowsiness.</p> <p style="text-align: right; font-size: small;">www.acec.com</p>

CNTRN-0053C-A

**DANGER:**  
**DO NOT USE SWIM STEP  
 WHILE ENGINE IS RUNNING**

CNTRN-0051C-A

**WARNING**

LEAKING FUEL IS A FIRE AND EXPLOSION HAZARD. INSPECT SYSTEM REGULARLY. EXAMINE FUEL TANKS FOR LEAKS OR CORROSION AT LEAST ANNUALLY.

CNTRN-0046C-A

**EXHAUST WARNING**

Exhaust fumes can cause carbon monoxide poisoning and death. Do not use, touch or loiter on swim step while motor is running. Teak surfing or dragging on the swim step of the boat while the engine is running is illegal and can cause death or injury.

CNTRN-0047C-A

**WARNING**

If you smell exhaust at anytime, remove yourself from that area immediately. Exhaust can carry Carbon Monoxide that can cause injury or death.

CNTRN-0048C-A

**ATTENTION**

**DO NOT OPERATE  
 MULTIPLE ELECTRICAL  
 OPTIONS SIMULTANEOUSLY  
 WITHOUT ENGINE RUNNING  
 (IN WATER)  
 OR SYSTEM MAY OVERLOAD.**

CNTRN-0056C-A

FINELINE INDUSTRIES INC. ASSUMES NO LIABILITY FOR PERSONAL INJURY OR PROPERTY DAMAGE RELATING TO THE USE OF ANY WATER SKI TOWING DEVICE INSTALLED ON THIS BOAT. THIS INCLUDES BAREFOOT BOOMS, TRICK RELEASES, PYLON EXTENSIONS OR RELATED APPARATUS.

CNTRN-0040C-A

CNTRN-0058C-A

Figure 3-2

**CAUTION**  
DO NOT OPERATE BALLAST SYSTEM WITHOUT WATER FLOWING THROUGH PUMP AS PUMP PROPELLER MAY BE DAMAGED CAUSING PUMP TO OVERHEAT  
DO NOT OVERFILL BALLAST TANK

CNTRN-0044C-A

**CAUTION**  
THE ENGINE BLOCK MAY OR MAY NOT HAVE BEEN DRAINED AT FACTORY. TAKE ALL MEASURES APPROPRIATE TO INSURE PROPER WINTERIZATION.

CNTRN-0045C-A

**CAUTION**  
DO NOT ENTER OR EXIT COCKPIT WHILE ENGINE IS RUNNING.  
TOP FUEL PRIOR TO EACH OPERATION.  
DO NOT OPERATE AFTER SUNSET OR BEFORE SUNRISE.  
CHECK OIL AND TRANSMISSION LEVELS PRIOR TO EACH OPERATION.  
IF LOW OIL OR HIGH TEMPERATURE LIGHT COMES ON, STOP OPERATIONS AND CONSULT DEALER.  
USE CAUTION FOR PROPELLER UNDER BOAT

CNTRN-0052C-A

**THIS BOAT IS NOT EQUIPPED WITH INTERNATIONAL LIGHTING**

CNTRN-0041C-A

**OWNERS RESPONSIBILITY TO TIGHTEN SKI PYLON**

CNTRN-0043C-A

**UNEVEN WEIGHT DISTRIBUTION MAY ADVERSELY AFFECT HANDLING**

CNTRN-0054C-A

**CAUTION**  
SKI LOCKER MUST BE LOCKED WHEN BOAT IS MOVING, OR DAMAGE MAY OCCUR

CNTRN-0042C-A

**PERSONS AND EQUIPMENT SHOULD NOT EXCEED 250 LBS. IN FORWARD BOW DURING OPERATION.**

CNTRN-0049C-A

**BATTERY CABLES MUST REMAIN TIGHT AT ALL TIMES  
LOOSE CABLES MAY CAUSE IGNITION OR OTHER FAILURE  
POSITIVE CABLE IS DISCONNECTED AT FACTORY PRIOR TO SHIPPING TO PREVENT BATTERY DISCHARGE FROM LACK OF USE.**

CNTRN-0055C-A

CNTRN-0059C-A

Figure 3-3

## Safety Statements

There is no substitute for common sense and careful practices. Improper practices or carelessness can cause burns, cuts, mutilation, asphyxiation, other bodily injury or death. This information contains general safety precautions and guidelines that must be followed to reduce risk to personal safety. Special safety precautions are listed in specific procedures. Read and understand all of the safety precautions before operation or performing repairs or maintenance.



Note: This safety alert symbol appears with most safety statements. It means attention, become alert, your safety is involved! Please read and abide by the message that follows the safety alert symbol.



### DANGER

Indicates a hazardous situation which, if not avoided, **will** result in death or serious injury.



### WARNING

Indicates a hazardous situation which, if not avoided, **could** result in death or serious injury.



### CAUTION

Indicates a hazardous situation which, if not avoided, **could** result in minor or moderate injury.

### NOTICE

*Used to address practices not related to personal injury.*

### Safety Precautions



The safety messages that follow have **DANGER** level hazards.

These safety messages describe hazardous situations which, if not avoided, *will* result in death or serious injury.

**Do not permit anyone to install or operate the boat without proper training.**

- Read and understand this *Operator's Manual* before you operate or service the boat to ensure that you follow safe operating practices and maintenance procedures.
- Safety signs and decals are additional reminders for safe operating and maintenance techniques.
- See your authorized boat dealer for additional training.

#### Exhaust Hazard



**Carbon monoxide (CO) is a colorless and odorless gas produced by all engines, fuel-burning appliances, and any material that contains carbon and is burned.**

- Even with the best boat design and construction, plus the utmost care in inspection, operation and maintenance, hazardous levels of CO may still be present in accommodation areas under certain conditions. To reduce CO accumulation, always provide adequate ventilation in the boat interior by opening the deck hatches, windows or canvas.
- Carbon monoxide poisoning should not be confused with seasickness, intoxication or heat stress. If someone complains of irritated eyes, headache, nausea, weakness, dizziness or drowsiness, or you suspect carbon monoxide poisoning, immediately move the person to fresh air, investigate the cause, and take corrective action. Seek medical attention if necessary.

#### Explosion Hazard



**While the engine is running or the battery is charging, hydrogen gas is being produced and can be easily ignited. Keep the area around the battery well-ventilated and keep sparks, open flame and any other form of ignition out of the area.**

 **WARNING**

The safety messages that follow have **WARNING** level hazards.

These safety messages describe hazardous situations which, if not avoided, *could* result in death or serious injury.

**Fire Explosion Hazard**

Gasoline is extremely flammable and highly explosive under certain conditions.

- Do not smoke or allow open flame or sparks nearby when refueling.
- Stop all engines, motors and fans before refueling.
- Maintain contact between the fuel nozzle and the fuel tank or container to prevent electrostatic spark. Do not use a plastic funnel.
- Run the blower (if equipped) to clear the engine compartment of gasoline vapors for at least five minutes **BEFORE** turning on any electrical devices or starting the engine.
- Do not block fuel vents.
- Do not store fuel in any containers or compartments which are not designated for fuel storage and do not use these storage areas for any other purpose.
- Gas discharged by a fire extinguisher system displaces oxygen to smother the fire. If the fire is in the engine compartment, do not open the hatch for at least 15 minutes after the fire extinguisher system operates. Oxygen from the open hatch can feed the fire and cause a flashback.

**Runaway Boat Hazard**

The engine emergency stop switch and lanyard are extremely important safety devices that should always be used when operating the engine. These safety devices will prevent the boat from becoming a runaway if the operator is accidentally thrown from the seat or away from the helm.

### WARNING

#### Entanglement Hazard

Rotating or moving parts can entangle or sever body parts.



- Do not wear jewelry, unbuttoned cuffs, ties or loose-fitting clothing.
- Tie long hair back when working near moving or rotating parts such as the flywheel or propeller shaft.
- Keep hands, feet and tools away from all moving parts.
- Keep all guards in place when engine is operating.
- Use caution when working with ski or mooring lines so they do not become entangled with the propeller.

#### Exposure Hazard

Do not mix cleaning agents together; harmful vapors may be released. Read and follow safety-related precautions found on containers of hazardous substances like parts cleaners, primers, sealants and sealant removers.



#### Fire and Explosion Hazard

Hydrogen gases produced by a lead acid battery while it is charging, or the engine is running, can cause an explosion and/or a fire.

Gasoline is extremely flammable and highly explosive under certain conditions.



- Wear personal protective equipment when working on or around batteries.
- Do not smoke or bring a flame near a battery.
- Do not check for a dead battery by placing a metal object between the battery posts. Sparks could cause an explosion.
- Do not place your head directly above a battery when making or breaking electrical connections.
- Charge the battery outside of the boat.
- Do not use a battery booster to start your engine.

## WARNING

### Lifting Hazard

Special equipment is necessary to lift the boat and/or engine. Always use lifting equipment with sufficient capacity to lift the boat and/or engine.

### Alcohol and Drug Hazard



Do not operate the boat while you are under the influence of alcohol or drugs or are feeling ill.

### Exposure Hazard



Wear personal protective equipment including appropriate clothing, gloves, work shoes, eye and hearing protection as required by the current task.

## CAUTION

The safety messages that follow have CAUTION level hazards.

These safety messages describe hazardous situations which, if not avoided, *could* result in minor or moderate injury.

Wear eye protection when servicing the boat or when using compressed air or high-pressure water. Dust, flying debris, compressed air, pressurized water or steam may injure your eyes.

### Poor Lighting Hazard

Ensure that the work area is adequately illuminated. Install wire cages on portable safety lamps.

### Tool Hazard

Use tools appropriate for the current task. Use the correct size tool for loosening or tightening machine parts.

### Slip and Trip Hazard



Keep the boat free of water, oil, mud and other foreign matter. Remove anything that creates slippery areas around the boat.



### NOTICE

*The safety messages that follow have NOTICE level hazards.*

*These safety messages are used to address practices not related to personal injury.*

*Modifications may impair the boat's safety and performance characteristics and shorten the boat's life. Any alterations to this boat may void its warranty.*

#### **Environmental Hazard**



**ALWAYS** be environmentally responsible. Follow the guidelines of the EPA or other governmental agencies for the proper disposal of hazardous materials such as engine oil and fuel. Consult the local authorities or reclamation facility.

## CARBON MONOXIDE

Carbon monoxide (CO) is a colorless and odorless gas produced by all engines, fuel-burning appliances, and any material that contains carbon and is burned. Even with the best boat design and construction, plus the utmost care in inspection, operation and maintenance, hazardous levels of CO may still be present in accommodation areas under certain conditions. To reduce CO accumulation, always provide adequate ventilation in the boat by keeping all areas open and vent enclosures if applicable. **DANGER! Direct and prolonged exposure to CO will cause brain damage or death.**

### Potential Causes of CO Poisoning While Under Way

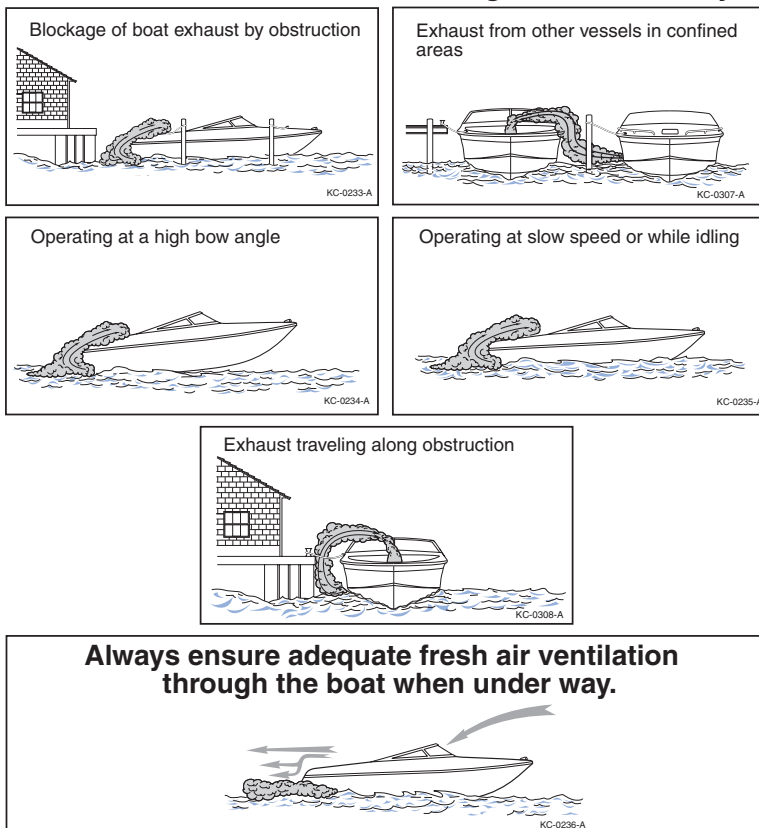

KC-0301-B

Figure 3-4

## REQUIRED BOATING SAFETY EQUIPMENT AND REGULATIONS

### U.S. Coast Guard Minimum On-Board Personal Safety Equipment Required

	Less than 16 ft (4.8 m)	CLASS 1: 16 to less than 26 ft (4.8 to less than 7.9 m)	CLASS 2: 26 to less than 40 ft (7.9 to less than 12.2 m)	CLASS 3: 40 to 65 ft (12.2 to 19.8 m)
<b>LIFE JACKETS</b>	One Coast Guard-approved Type I, II, III or V wearable life jacket for each person on-board	One Coast Guard-approved Type I, II, III or V wearable life jacket for each person on-board and one throwable Type IV PFD device		
<b>FIRE EXTINGUISHERS</b>	One B-I type (Coast Guard-approved).  If the vessel meets any one or more of the following conditions, the vessel must carry one B-I type USCG-approved extinguisher on-board <ul style="list-style-type: none"> <li>• Inboard/Sterndrive engine powered</li> <li>• Has closed compartments where portable fuel tanks can be stored</li> <li>• Has double bottom construction that has areas where air or gases can be open or trapped</li> <li>• Has an enclosed living space</li> <li>• Has compartments where flammable, combustible or explosive materials are stored</li> <li>• Has permanent fuel tanks installed</li> <li>• Vessel is 26 ft (7.9 m) or more in length.</li> </ul>	One B-II or two B-I type (USCG-approved) (A fixed extinguishing system is equal to one B-I.)	One B-II AND one B-I OR three B-I type (USCG-approved) (A fixed extinguishing system is equal to one B-I or two B-II.)	
<b>VISUAL DISTRESS SIGNALING DEVICES</b>	One (1) electric distress light OR three (3) day and night combination red flares	One orange distress flag or one electric distress light OR three floating or handheld orange smoke signals and one electric distress light OR three day and night combination red flares, handheld, parachute or meteor type		

	Less than 16 ft (4.8 m)	CLASS 1: 16 to less than 26 ft (4.8 to less than 7.9 m)	CLASS 2: 26 to less than 40 ft (7.9 to less than 12.2 m)	CLASS 3: 40 to 65 ft (12.2 to 19.8 m)
<b>AUDIBLE DISTRESS SIGNALING DEVICES</b>	A vessel less than 39.4 ft (12 m) must have on-board an efficient sound-producing device. (Example: hand or mouth whistle OR a compressed or powered air horn)		A vessel less than 39.4 ft (12 m) must have on-board an efficient sound-producing device. (Example: hand or mouth whistle OR a compressed or powered air horn) A vessel 39.4 ft (12 m) but less than 65.6 ft (20 m) in length operating in inland waterways must carry a power whistle or powered air horn AND a bell.	
<b>NAVIGATION LIGHTS</b>	Regulations require that navigational lights be clearly lit and properly displayed at all times between sunset and sunrise and always when operating in reduced visibility while boating.			

## Fire Extinguisher

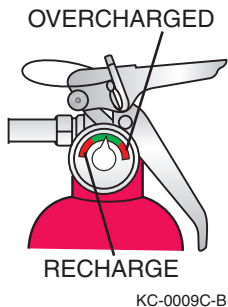

USCG-approved fire extinguishers are required on all Class I, II and III boats. Mount all handheld fire extinguishers in readily accessible areas away from the engine compartment and other combustible devices. All passengers should know the location and operating procedure of each extinguisher. Follow the manufacturer's instructions for proper use and operation of the fire extinguisher.

All fire extinguishers used on marine boats must be classified to extinguish type B fires (gasoline, oil or grease). The size and number of required fire extinguishers depend on the size of the boat. The two type B fire extinguishers commonly used are B-I and B-II. Type B fire extinguishers are classified by the different extinguishing compound amounts used in each.

Check the fire extinguisher condition and pressure gauge regularly, if not before every trip, to ensure that the fire extinguisher is in good operating condition and is fully charged. If the fire extinguisher is damaged or not properly pressurized, replace it.

For specific on-board requirements, see *U.S. Coast Guard Minimum On-Board Personal Safety Equipment Required* on page 3-14.

## Life Jackets

All passengers on boats up to and including Class III boats must wear a USCG-approved Type I, II, III or V life jacket.

All Class I, II and III boats must have one USCG-approved Type IV throwable PFD on-board.

All passengers, especially children and nonswimmers should always wear a life jacket when boating. All life jackets should be in a readily accessible area and within immediate reach.

All passengers should know the location of the life jackets and how to wear and adjust them. Follow the manufacturer's instructions for proper use, care and operation of the life jacket.

Each USCG-approved life jacket on-board must:

- Clearly show the manufacturer's name
- Clearly show the USCG approval label and number
- Be an appropriate size and type for each person on-board
- Be in good, usable condition

Selecting the proper life jacket application type and size is important to your safety while boating. There are four application types of wearable PFD's and one type that is used only for throwing in emergency situations. Life jackets may include inherently buoyant designs (do not require inflation) or inflatable (manual and manual with automatic backup). Life jacket sizes generally correspond to chest size and weight.

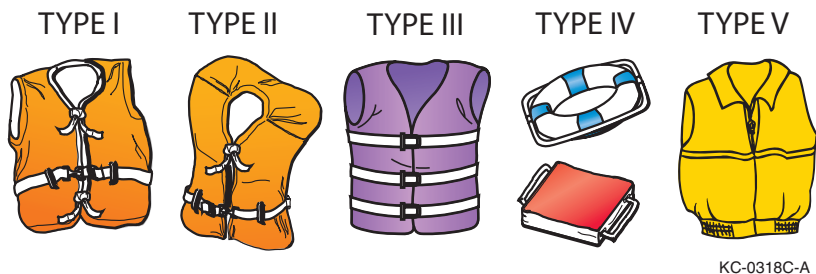

**Figure 3-5**

### Type I

This life jacket is designed so that the person wearing it turns to a face-up position when conscious or unconscious. Type I life jackets are the most buoyant and are effective on all waters, especially when rescue is delayed or flotation time is extended.

## **Type II**

This life jacket is recommended for use in calm water near shore on most inland waters where quick rescue is likely. A Type II life jacket is similar to a Type I life jacket but is not as buoyant or effective in turning the wearer to a face-up position.

## **Type III**

This life jacket is designed for personal buoyancy when the wearer is alert and conscious. Type III life jackets require users to turn themselves to a face-up position. Type III life jackets are recommended in most inland water applications where quick rescue is likely or when used in the presence of other people.

## **Type IV**

This PFD is designed to be thrown to a person in the water who can grab and hold it while being rescued. A Type IV PFD should never be worn.

## **Type V**

This life jacket is designed for special activities and may be worn instead of a Type I, II or III life jacket if used in accordance with the approval conditions on the label. If a Type V life jacket is part of the minimum on-board life jacket requirements, it must be worn at all times when boating if it has a label that indicates “required to be worn”; otherwise one additional Type I, II or III life jacket must be on-board to satisfy the minimum life jacket requirements. Some Type V life jackets provide increased protection against hypothermia.

Other special life jackets are available for skiing and other water sports. These life jackets are constructed with materials suitable for high impact falls. When selecting these life jackets, ensure that they meet USCG approval requirements.

**Note:** Inflatable USCG-approved life jackets are not to be used by persons under the age of 16.

## **Children’s Life Jackets**

All life jackets are clearly labeled with the appropriate weight range. Check the label to match the weight range of your child. To check for a good fit, pick the child up by the shoulders of the life jacket. If the life jacket fits, the child’s chin and ears will not slip through.

Children weighing between 30 and 50 pounds may like the freedom of movement that a Type III life jacket provides, however most children in this weight range, especially those who cannot swim, should wear a Type I or Type II life jacket.

- Use a life jacket with a collar that turns a child’s face up in the water. It must have strong straps and buckles, a handle on the collar and be preferably bright yellow or orange in color for high visibility.

## Section 3

- Attach a plastic safety whistle to the life jacket and teach and practice with the child on how to use the whistle and signal for help.

Note: Inflatable USCG-approved life jackets are not to be used by persons under the age of 16.

### Audible Distress Signaling Devices

Audible (sound) distress signals are required to be on-board all boats. A boat less than 39.4 feet (12 meters) must always have an efficient sound-producing device on-board (Example: hand or mouth whistle, or a compressed or powered air horn).

A boat at least 39.4 feet (12 meters) but less than 65.6 feet (20 meters) operating in inland waterways must always have a power whistle or powered air horn and a bell on-board.

All devices must be acceptable for use in marine environments, audible for 1/2 nautical mile and maintain a continuous four to six-second sound duration. The diameter of the bell's mouth must be a minimum of 7.9 inches (241 centimeters).

All passengers should understand how to operate all audible distress signaling devices on-board. Keep these devices in a readily accessible area and within immediate reach at all times when boating.

For specific on-board requirements, see *U.S. Coast Guard Minimum On-Board Personal Safety Equipment Required* on page 3-14 and for usage information, see *Audible Distress Signals* on page 7-1.

### Visual Distress Signaling Devices

Boats less than 16 feet (4.9 meters) must have USCG-approved Visual Distress Signals (VDS) on-board when operating between sunrise and sunset in coastal waters including ocean bays, gulfs and sounds, as well as the Great Lakes, seas, bays, sounds and river mouths that are 2 or more miles wide and only to the point proceeding inland where the water narrows to less than 2 miles. Visit the U.S. Coast Guard website for additional information on specific VDS requirements for your boat.

All passengers on-board should understand how to operate all VDS. Keep VDS in a readily accessible area and within immediate reach at all times when boating.

## VISUAL DISTRESS SIGNALS

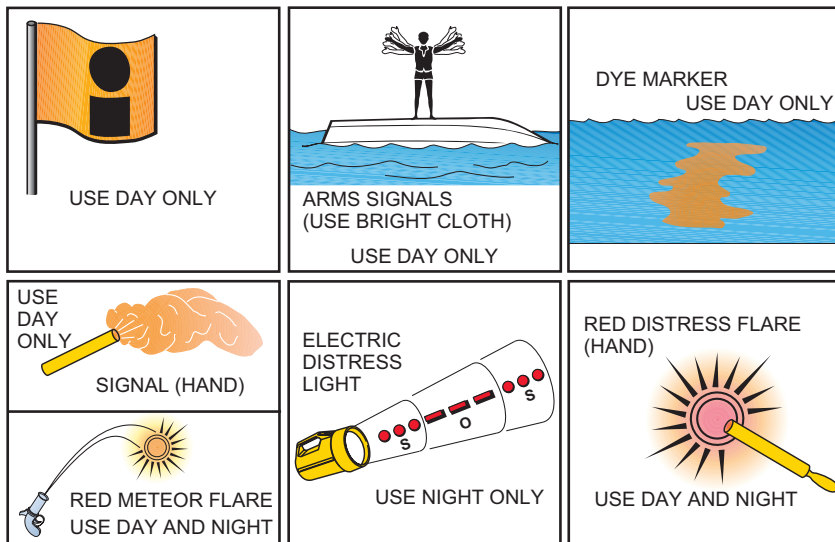

KC-0008C-B

**Figure 3-6**

Regulations prohibit using pyrotechnic VDS or any VDS in non-emergency situations.

VDS must be:

- USCG-approved
- in proper operating condition
- safely stowed and readily available
- within the clearly marked expiration date stamp on the device (where applicable)

Types of VDS vary by emergency situation. VDS are classified as either pyrotechnic or non-pyrotechnic.

**Note:** Some pyrotechnics may be restricted on certain bodies of water. Check with local authorities, or visit the National Association of State Boating Law Administrators (NASBLA) website: <http://www.nasbla.org> or the U.S. Coast Guard website: [www.uscg.org](http://www.uscg.org) for additional information.

For specific on-board requirements, see *U.S. Coast Guard Minimum On-Board Personal Safety Equipment Required on page 3-14*.



### Engine Emergency Stop Switch and Lanyard

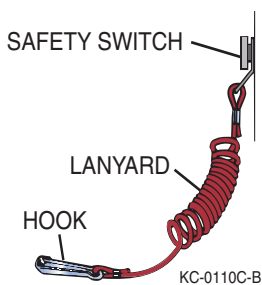

The engine emergency stop switch is an extremely important safety precaution that should always be used when operating the boat's engine. This safety device prevents the boat from becoming a runaway if the operator is accidentally thrown from the seat or away from the helm.

Before turning on the boat's engine, secure the engine emergency stop switch lanyard to the boat operator. If the operator is thrown from the seat or moves too far from the helm, the lanyard will disconnect from the switch, activating the switch to turn off the engine.

Never remove or modify the engine emergency stop switch and/or lanyard.

Always keep the lanyard free from obstructions that could interfere with its operation.

Always check the switch for proper operation. With the engine running, pull the lanyard. If the engine does not stop, have the switch repaired before continuing to operate the boat. Never operate the boat if the engine emergency stop switch does not work.

### Navigational Lights

Navigational lights are intended to alert other boats to your presence and course.

Regulations require that navigational lights be clearly lit and properly displayed at all times between sunset and sunrise, and always when operating in reduced visibility. The placement, shape and visibility requirements of navigational lights may vary depending on usage. Check with local authorities, or visit NASBLA or the U.S. Coast Guard website for additional information.

For additional information, see *Navigational Lights & Night Operation* on page 7-2.

## RECOMMENDED SAFETY EQUIPMENT

Know how to use and carry the following equipment in addition to the required equipment on-board at all times as an extra safety precaution:

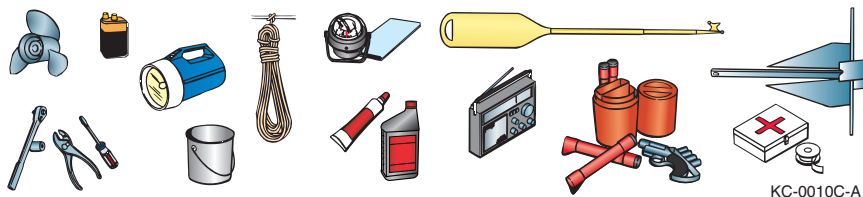

**Figure 3-7**

Anchor and line with minimum 75 feet (23 meters) of line	Insect repellent
Auxiliary starting battery	Local charts and compass
Boat hook	Mooring lines
Cellular phone	Navigational and interior light bulbs
Compass	Oar/paddles
Dock fenders	Life jackets
Duct and electrical tape	Propeller, nut and washer
Electrical wire	Radio
Emergency food and water	Engine lubricant
Emergency Position Indicating Radio Beacon (EPIRB)	Spark plugs
Extra keys	Sunglasses and sun block
Extra drain plug	Thermal clothing
First aid kit and manual	Tool kit including propeller replacement tools
Flashlight	Tow line
Flashlight and radio batteries	VHF-FM/AM with weather band radio
Foul weather gear/clothing	Visual distress signals
Fuses	Waterproof flashlight
GPS Global Positioning Device	

# WATER SPORTS SAFETY

Only boats equipped with a ski-tow eye, pylon, bar, tower or other specially designed line attachment device should be used to pull persons or equipment engaged in a water sport. **DANGER! It is unlawful to participate in water sports while under the influence of alcohol or other drugs.**

Water sports may include, but are not limited to, any activity performed in the water such as wakeboarding, wake surfing, wake skating, swimming, diving, snorkeling, knee boarding, tubing, skiing, parasailing, kiting, gliding or any activity using a device that may be pulled or pushed by a boat.

Check with local and state authorities or water sports clubs and affiliations for additional information.

## Teak or Platform Dragging

Every year tragic deaths occur from the negligence of unsafe boating and dangerous activities. **NOTICE: It is UNLAWFUL to be on or holding on to the boarding platform, swim deck, swim step, swim ladder or any portion of the exterior of the transom at any time while the boat is running or under way in any direction and at any speed.**

**WARNING! Body, teak or platform dragging is extremely dangerous and can be fatal. Never hold on to the transom of a boat while in the water when the boat is running or under way.**

- Do not use the boarding platform or ladder for any purpose other than boarding the boat or entering the water.
- Do not use the boarding platform or ladder while the engine is running.
- Do not swim under the boarding platform when the engine is running.

These dangerous and even fatal activities can lead to any or all of the following, as well as other dangers not listed here:

- Carbon monoxide poisoning
- Severe injury from a rotating propeller
- Drowning
- Entrapment under the water

## Water Sports Guidelines

The following water sport guidelines only cover the general conditions that arise frequently. The participants must respond to the constantly changing weather and the conditions of the sea by using reasonable and safe judgment in light of the circumstances.

## Boat Operator, Occupants and Participants

- Always be safe and courteous. Be considerate to fishermen and all others with whom you share the water.
- Always ensure that all water sports participants and occupants of the boat, especially the operator, are fully aware at all times of the participants' condition and location in the water, as well as the surrounding environment.
- Safety should always be the primary concern of all involved during the activity. Only allow safe and capable participants to engage in the activity.
- The boat operator or water sports participants should always know their limitations in the activity and never exceed them.
- Never perform water sports in or near:
  - Congested areas
  - Restricted areas
  - Navigation or other waterway markers
  - Other boats
  - Other water sports participants
  - Obstructions in the water
  - Shorelines
  - Shallow water
  - Hazardous weather conditions
  - Hazardous waterways, rapid moving water, dams, spillways, etc.
  - Areas or times of restricted visibility
  - Hours between sunset and sunrise
  - Locations too far from shore to hinder immediate rescue or emergency help if needed
- Always engage in water sports activities in safe waterways only.
- Always attach the water sports tow rope to approved attachment points on the boat.
- Never jump from a boat that is moving at any speed, and do not enter or exit the water when the engine is running.
- Never use different length ropes simultaneously for water sports activities.
- Always make sure that participants know and use approved skiing hand signals and common skiing courtesies.
- Before starting always agree to speed and communication hand signals between the boat operator, spotter/observer and participants.
- Before starting always inspect the water sports equipment and tow eye, tow point, and towline for safe operating condition, or damage that may lead to failure.

### Boat Operator Specific Guidelines

The following guidelines are for the boat operator while a participant is in the water.

- Always have a “spotter” (designated observer) other than the boat operator on-board to ensure the safety of the participants in the water and provide communication to and from the boat operator and the participants.
- Always turn the engine off from a safe distance when approaching participants in the water and allow them to reach the boat. Never run the engine near a person in the water.
- Never operate the boat in reverse to retrieve anyone in the water.
- Always return immediately to a fallen water sports participant. Always approach the participant on the operator’s side while keeping the participant in view from a direction opposite the wind or seas.
- Never drive directly at a person in the water or directly behind another boat.
- Always maintain a safe distance from people and objects in and on the water.
- Always look in the direction you plan to turn before turning the boat to pick up a fallen skier.
- Never retrieve any object from the water while the engine is running.
- Always keep the skier in view when the skier is entering or exiting the boat.
- Always watch the skier as the line begins to tighten (in case the rope wraps around ski or skier).
- Always look ahead before starting.
- Always start from a safe place with good forward and peripheral visibility.
- Always check direction of steering before starting, ensuring that the boat steers straight.
- Always be aware of what is occurring in front of the boat and of a participant's condition.
- Always display a “skier down” flag whenever a skier is in the water and not skiing.
- Always follow the approved towing pattern for the waterway in which you are operating.

### Additional Guidelines for Participants in the Water

The following guidelines are for the water sport participant.

- Never participate in water sports if you cannot swim.
- Always wear a bright-colored USCG-approved activity life jacket at all times. You should also wear suitable protective clothing or gear and/or a wet suit to prevent impact injuries, abrasions and hypothermia.
- Never approach or enter the boat if the engine is running.
- Always avoid the boat's propeller. Even when the propeller is not rotating, its sharp edges can cause serious injury.

- Never put any part of your body through the handle of the ski line or wrap the line around any part of your body.
- Never enter the water from a boat that is running or moving at any speed.
- Always indicate that you are clear of the boat prior to the operator starting the boat or putting the boat into gear and tightening the rope.

## Skiing

Water-skiing is a team sport including a driver, observer and skier. The degree of understanding and cooperation between them directly determines the success and enjoyment of the venture. All must understand that the skier is an extension of the boat.

A moderate ability to swim is advisable for water-skiers, but swimming ability is no substitute for a well-fitting life jacket. Wearing of a life jacket or personal flotation device (PFD) is essential even for expert swimmers. The life jacket should be Type III, approved by the USCG and designated as a ski jacket. The life jacket should fit snugly; otherwise it could slip up over the skier if the skier should happen to fall at high speed.

When starting, the driver should watch the skier. The driver then will know when to apply and regulate the power. At the same time, the observer should watch for other boats and obstacles in the boat's path. Once under way, the observer watches the skier and the driver controls the boat.

Allow the skier plenty of time to prepare in the water. Be aware of the direction the boat is facing.

Idle the boat straight away from the skier until the line is tight. Be sure the skier is directly behind the boat.

On the skier's command, start accelerating to the agreed upon speed. Adjust only per the skier's request.

**Note:** If a novice skier is having difficulty staying up, pull the skier up a little easier. Decrease the boat speed so the skis track better and use wide gradual turns.

Communication between the skier and driver is essential. Standard signals have been developed by the American Waterski Association and have been accepted by most water-skiers. Once the skier is in the water and ready, the driver of the boat will take the slack out of the tow line. When the skier is in position and prepared for lift, the skier shouts "hit it" which is the signal for the driver to open the throttle for take-off. Once the skier is on plane, there are a number of hand signals that will allow communication between the skier and the driver of the boat.

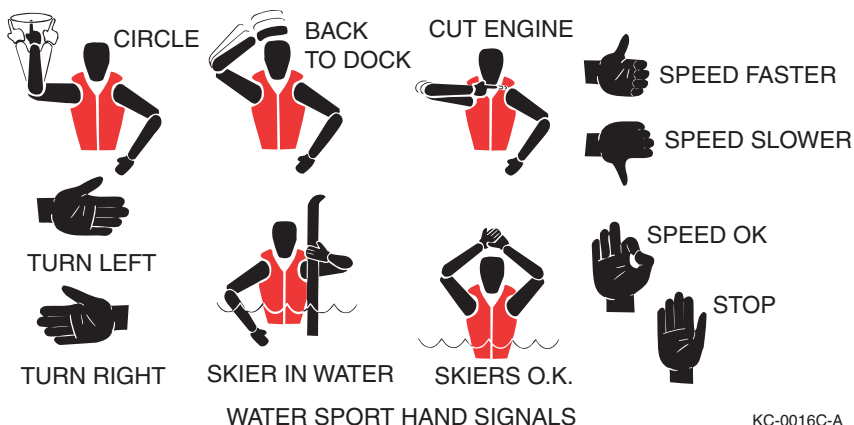

**Figure 3-8**

## Fallen Skier

Immediately confirm the condition of the skier. If OK, keep the skier in sight and return slowly. Circle the skier at a safe distance to return the ski rope and handle to the skier on the driver's side of the boat. Do not allow the ski rope to contact the propeller.

Make sure the skier is not tangled in the ski rope before getting under way.

If a skier is injured, return immediately to the skier without creating waves or losing control of the boat. When near the skier, have the observer enter the water while wearing a life jacket to confirm the status of the skier and assist if necessary. Board the skier if possible; otherwise seek additional help.

## Ski Tow Line Safety

The majority of water sports injuries are the result of impact with other objects. Be aware of what is around you and look where you are going. Have an experienced operator at the helm and always have at least three people present for safe towing – one to drive, one to observe, and one to ski or ride.

Consult your dealer before using a ski pylon extension or other similar accessories. Using these accessories could create excessive stress damage to your boat. Such damage may not be covered by warranty.

Never wrap ski tow lines or mooring lines around any body part. You could become entangled in the line if you fall overboard while the boat is moving.

Keep track of ski tow lines and dock lines so they do not become entangled in the propeller.

## Boat Pattern

A large loop pattern is preferred for beginners. This pattern does not require the skier to cross the wake. As the skier's skills improve, a looped end or dumbbell pattern may be used. The dumbbell pattern provides a long straight course which allows the wake to disperse, leaving the skier with a smooth water surface. The dumbbell pattern is popular with ski tournaments and clinics.

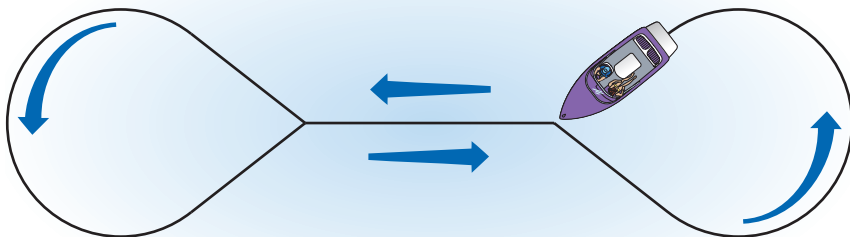

*Figure 3-9*

## Wakeboarding / Wake Surfing

Wakeboarding and wake surfing are hybrids of snowboarding and water-skiing and have become increasingly popular water sports. Like other water sports wakeboarding and wake surfing require skill, agility and, above all, attention to safety at all times.

The use of on-board ballast tanks to add weight to the boat is ideal for the type of large wakes desired for these types of water sports.

Always be aware of the wake your boat is creating and the effect it has on others in the water and on the shore. Check with the local authorities for the usage, speed and wake regulations for the area you are wakeboarding or wake surfing in before participating.



**This Page Intentionally Left Blank**

*Section 4*

## **BOATING REGULATIONS & YOUR RESPONSIBILITIES**

The U.S. Coast Guard (USCG) is the federal authority on U.S. coastal and inland waterways, but state and local regulations may exist that exceed USCG regulations. The purpose of all of these regulations is to assist the boating public and maintain navigational order on waterways.

Many state equipment requirements go beyond USCG requirements. Contact your state and local boating authorities for further information. Equipment requirements for coastal and inland waters differ. Check with local authorities or the USCG for further information about coastal water requirements.

Boating regulations are enforced by USCG, state and local authorities. You are subject to marine navigation regulations for both federal and state waterways. You must comply if enforcement officers signal you to stop your boat or if they ask to board your boat.

Many USCG, state and local resources are available to you. For additional and current information on regulations, safety and navigation, contact your local USCG unit or local marine authority.

See *References and Contact Information on page 1-6* for a list of resources.

### **BOAT OWNER / OPERATOR RESPONSIBILITIES**

As a boat owner/operator, understand and be aware of USCG federal regulations as well as state and local regulations where you operate your boat. Boating regulations include but are not limited to boat regulations, boat equipment regulations and navigational regulations.

You must have on-board at all times all mandatory safety and boat equipment as regulated by the governing authorities. All equipment must be maintained in proper working order.

### SAFETY

As a boat owner/operator you are legally responsible for your safety, the safety of your passengers and the safety of other boaters. In addition, you are responsible for the operation and navigation of your boat under all operating conditions. Your boat must be in compliance with USCG safety equipment regulations.

### REGISTRATION

The USCG requires that all power boats operated on the navigable waters of the United States be currently registered in the state in which they are principally used. Many states require current registration in that state whenever boating on waters within their state boundary. Always contact your state boating authorities (and authorities in neighboring states) for registration information on boats and trailers.

Registration numbers must be current and clearly displayed on the boat according to the defined regulations. Registration certificates must be current and on-board at all times.

State and local authorities may require additional registration for boating on certain waterways. Check with state and local authorities for additional registration information.

For more information visit:

- U.S. Coast Guard Office of Boating Safety <http://www.uscgboating.org>
- National Association of State Boating Law <http://www.nasbla.org>

### INSURANCE

As a boat owner you are legally responsible for any damage or injury caused when you or someone else is operating your boat when an accident or collision occurs. Individual states have laws detailing minimum insurance needs. Contact your insurance agent to verify the type of insurance you need **before** operating your new boat.

### REPORTING ACCIDENTS

The USCG requires the owner/operator of a boat involved in an accident to report the incident to the proper marine law enforcement agency for the state in which the accident occurred. If a person dies or disappears as a result of a recreational boating accident, the boat owner/operator must immediately notify the nearest state boating authority. If a person dies or injuries requiring more than first aid are involved, the owner/operator must file a formal report within 48 hours of the accident. An owner/operator has 10 days to file a formal report for accidents exceeding \$500 in property damage or complete loss of boat.

# Boating Regulations & Your Responsibilities

## BOATING UNDER THE INFLUENCE



KC-0011C-B

Federal and state laws prohibit the operation of a boat while under the influence of alcohol or drugs and authorities actively enforce these regulations. If the operator's blood alcohol content is 0.08% or above, violators are subject to civil and criminal penalties and imprisonment. Operating a boat under the influence can also result in a loss of motor vehicle driving privileges.

Alcohol and drugs slow your reaction time and affect your judgment. This type of impaired operation may result in death or severe personal injury.

As the owner/operator, you are responsible for the alcohol and drug use, as well as on-board behavior, of your passengers.

Regulations and penalties for operators and passengers may vary from state to state. Contact your local and state boating authorities for specific information.

## OPERATOR'S LICENSE AND EDUCATION

This manual does not provide complete training on all aspects of boating safety, operation or regulations. Boating authorities highly recommend that all boat operators and passengers seek additional training in boating safety and seamanship from a USCG-approved course.

Some states require youths 16 years of age and younger to complete a boating safety course before operating any watercraft. Many others require operators under the age of 18 to be licensed in small boat operation.

Check with your state and local authorities for requirements of operator's license, certificate or training before you or anyone operates your boat.

See *References and Contact Information on page 1-6* for a list of some of the agencies and organizations that offer water/boating safety courses, first aid/CPR, or other recommended training and/or information.

## OPERATION BY MINORS

Minors must always be supervised by an adult whenever operating a boat. Many states have laws regarding the minimum age and licensing requirements of minors. Regulations may vary from state to state. Contact your local and state boating authorities for specific information.

### EMERGENCY ASSISTANCE

If you see a distress signal or suspect a boat is in trouble, you must assume it is a real emergency and render assistance immediately. By law, the operator in charge of the boat is obligated to provide assistance to any individual in danger if such assistance can be provided safely. Failure to render assistance can result in a fine and/or imprisonment. The 1971 Boating Safety Act grants protection to a “Good Samaritan” boater providing good faith assistance, and absolves a boater from any civil liability arising from such assistance.

### PROTECTING THE ENVIRONMENT

As a boat owner/operator you are responsible for protecting wildlife and the natural environment by keeping waterways clean. There is currently a tremendous drain on our natural resources. Excessive fishing and hunting, as well as pollution, have strained the fish and game population. Do your part by keeping only what you will eat; practice catch-and-release and obey bag limits.

### FOREIGN SPECIES TRANSPORTATION

If you trailer your boat from lake to lake, you may unknowingly introduce a foreign aquatic species from one lake to the next. Thoroughly clean your boat below the waterline, remove all weeds and algae, and drain the bilge and livewells before launching your boat in a new body of water.

### NOISE

As a boat owner/operator you are responsible for the noise your boat creates. Many state and local boating authorities enforce noise limits that may restrict engine noise, radio volume or even loud talking. Regulations may vary from state to state. Contact your local and state boating authorities for specific information.

### SPEED

As a boat owner/operator you are responsible for maintaining your boat under control at a safe speed. Many state and local boating authorities enforce speed limits. Regulations may vary from state to state. Contact your local and state boating authorities for specific information.

### WAKE

As a boat owner/operator you are responsible for the wake your boat creates. Regulations may vary from state to state. Contact your local and state boating authorities for specific information, as you may be responsible for any damage or injury your wake causes. You should always be alert for NO WAKE zones and be courteous of others while boating. Excessive and unexpected wakes can cause dangerous and even life-threatening situations.

# Boating Regulations & Your Responsibilities

## POLLUTION REGULATIONS

The discharge of any type of debris or waste, including but not limited to food, trash, garbage, oil, fuel, liquids and human waste, is highly restricted and sometimes considered unlawful in most waterways. Authorities highly recommend that you **never** discharge anything into the water.

Become familiar with the following pollution regulations. Pollution is a serious matter, and law enforcement authorities highly enforce these regulations. As a boat owner/operator you are responsible for your actions affecting the environment; therefore, you must fully understand and be aware of these regulations, and should seek additional information on them from the USCG, state and local authorities.

### MARPOL Treaty

The USCG enforces the International Convention for the Prevention of Pollution from ships, commonly referred to as the MARPOL Treaty (MARine POLLution). This treaty prohibits the overboard dumping of all ship-generated plastics, chemicals, garbage and oil. Contact the USCG for further information.

### Refuse Act of 1899

The Refuse Act of 1899 prohibits throwing, discharging or depositing refuse matter of any kind (including food, trash, garbage, oil and other liquid pollutants) into the U.S. waterways.

### Federal Water Pollution Control Act

The Federal Water Pollution Control Act prohibits the discharge of oil or hazardous, potentially harmful substances into U.S. navigable waters. Boats at least 26 feet (7.9 meters) in length must display a placard at least 5 by 8 inches (127 by 203 mm), made of durable material, fixed in a conspicuous place in the machinery spaces, or at the bilge pump control station, stating the following:

#### Discharge of Oil Prohibited

The Federal Water Pollution Control Act prohibits the discharge of oil or oily waste upon or into any navigable waters of the U.S. The prohibition includes any discharge which causes a film or discoloration of the surface of the water or causes a sludge or emulsion beneath the surface of the water. Violators are subject to substantial civil and/or criminal sanctions including fines and imprisonment.

### Federal Oil Pollution Act of 1990

The Federal Oil Pollution Act of 1990 was passed by Congress to prevent further oil spills from occurring in the U.S. As a boat owner you should be familiar with your liability under this act, as you may be liable for the cost of actions in the prevention and/or removal of, or damage from, oil spills created by you.

### Exhaust Emissions

As a boat owner you are responsible for the exhaust emissions from your boat. Increased exhaust (hydrocarbon) emissions, which are regulated by the EPA, pollute the water and air. Contact your dealer and the engine manufacturer for more information. Additional restrictions may apply and vary from state to state. Contact your local and state boating authorities for specific information.

### Proposition 65

A wide variety of components used on this vessel contain or emit chemicals known to the state of California to cause cancer, birth defects and other reproductive harm.

#### Examples include:

- Engine and generator exhaust
- Engine and generator fuel and other liquids, such as coolants and oil, especially used motor oil
- Cooking fuels
- Cleaners, paints and substances used for vessel repair
- Waste materials that result from wear of vessel components
- Lead from battery terminals and from other sources, such as ballast or fishing sinkers

#### To avoid harm:

- Keep away from engine, generator and cooking fuel exhaust fumes.
- Wash areas thoroughly with soap and water after handling the substances above.

# Boating Regulations & Your Responsibilities

## ⚠ WARNING

A wide variety of components used on this vessel contain or emit chemicals known to the State of California to cause cancer and birth defects and other reproductive harm.

### EXAMPLES INCLUDE:

Engine and generator exhaust.  
Engine and generator fuel, and other liquids such as coolants and oil, especially used motor oil.  
Cooking fuels.  
Cleaners, paints and substances used for vessel repair.  
Waste materials that result from wear of vessel components.  
Lead from battery terminals and from other sources such as ballast or fishing sinkers.

### TO AVOID HARM:

Keep away from engine, generator and cooking fuel exhaust fumes.  
Wash area thoroughly with soap and water after handling the substances above.

California Health & Safety Code 25249.5-13

KC-0206C-B

**Figure 4-1**

## State of California Requirements

Your boat may be equipped with an engine that meets the strict requirements outlined by the California Air Resources Board (CARB). If so, the engine has a special environmental tag and the boat has one of the following labels affixed to it. The tag and the label are required by CARB. The label has 1, 2, 3 or 4 stars and **must** be affixed to the boat if the boat is operated in the state of California and/or bordering waters.

For more information visit: <http://www.arb.ca.gov>



KC-0211-B

**Figure 4-2**



### **Cleaning Agents**

As a boat owner you are responsible for the environmental regulations that may govern the use of cleaning agents. Use household cleaners sparingly and never discharge them into waterways. Do not mix cleaners and be sure to use plenty of ventilation in enclosed areas. Avoid using chlorine, solvents and products that contain phosphates, as well as non-biodegradable or petroleum-based products. Regulations may vary from state to state. Contact your local and state boating authorities for specific information.

### **Paints**

As a boat owner you are responsible for the environmental regulations that may govern the use of antifouling paint. If your boat is kept in water where marine growth is a problem, the use of antifouling paint may reduce the growth rate. Regulations may vary from state to state. Contact your local and state boating authorities for specific information.

Section 5  
**EMERGENCIES**

Before operating your boat, see *Safety on page 3-1*.

Be prepared to deal with emergencies before they happen. Try to formulate a plan for each type of emergency in advance so you can make decisions quickly and without hesitation. Precious moments lost can mean the difference between losing and saving a life.

## FIRST AID / MEDICAL EMERGENCIES

Every second counts toward preventing injury or death in case of a medical emergency. Boaters should have proper training and take necessary preventive measures to properly assist in times of need. Carrying an adequate and current first aid kit is critical in the immediate response and care of someone in need of medical attention. Dry blankets should also be readily accessible to help prevent hypothermia. For additional information on medical, first aid and safety training such as CPR, contact your state and local authorities, or visit the Red Cross website: <http://www.redcross.org>

## EMERGENCY PREPARATION CHECKLIST

In addition to a safety equipment list, you should also have an emergency checklist on-board to assist in times of emergency. Use the following topics as a guideline to develop a list of emergency procedures and instructions for the use of visual and audible distress signaling devices, radios, first aid and all related information that could assist you or others in the event of an emergency.

## CARBON MONOXIDE POISONING

**DANGER! Carbon Monoxide (CO) is a colorless and odorless gas produced by all engines, fuel-burning appliances, and any material that contains carbon and is burned.**

- Carbon monoxide poisoning should not be confused with seasickness, intoxication or heat stress. If someone complains of irritated eyes, headache, nausea, weakness, dizziness or drowsiness, or you suspect carbon monoxide poisoning, immediately move the person to fresh air, investigate the cause, and take corrective action. Seek medical attention if necessary.

For additional information, see *Carbon Monoxide on page 3-13*.

# FIRE AND EXPLOSION

For additional information on extinguishing fires and specific fire extinguisher requirements, see *Fire Extinguisher* on page 3-15.

**DANGER! Gasoline is extremely flammable and highly explosive under certain conditions.**

- Do not smoke or allow open flame or sparks nearby when refueling.
- Do not store fuel in any containers or compartments which are not designated for fuel storage.
- Static electricity can be generated while fueling and can cause a fire or explosion. To prevent electrostatic spark when refueling, make sure the nozzle is in contact with the fill pipe at all times.
- Avoid damaging fuel lines and connectors and make sure fuel does not contact hot engine parts.
- USCG-approved fire extinguishers are required on all Class I, II and III boats.



KC-0252C-A

**Figure 5-1**

A fire or explosion may occur when you least expect it. Your decision to abandon the boat or stay to fight the fire is difficult and depends on many factors. Formulate a fire plan in advance to make that decision quickly and without hesitation. Keep in mind the following guidelines:

- Many fires are the result of gasoline and oil accumulating in the bilge, careless fueling practices and electrical problems. In the event of a fire, try to stop the boat and turn off the engine as quickly and safely as possible. Immediately use a fire extinguisher at the base of the flames in a sweeping motion to reduce or extinguish the fire. Ensure that all passengers are safe from immediate danger and are wearing life jackets. If the fire is located in the engine compartment (if equipped), make sure the bilge blower (if equipped) is off and do not open the engine cover.
- Once you have extinguished the fire, check for other immediate fire threats and personal injuries and call for assistance immediately.
- If you are unable to easily extinguish the fire, or if the fire is uncontrollable, attempt to get yourself and all passengers off the boat and into the water. If possible, ensure that all passengers are wearing life jackets or have access to one by the time they are in the water. Before leaving the boat, if possible, verify that there is no immediate danger of fuel sitting or burning on the water's surface where you and your passengers will be floating. Immediately swim to a safe position upwind from the boat and use distress signals to get assistance.

## USING DISTRESS SIGNAL DEVICES AND CALLING FOR HELP



All passengers should understand how to operate all on-board visual and audible distress signaling devices and communication equipment. Keep all distress signaling devices and communication equipment in a readily accessible area and within immediate reach at all times.

An emergency can occur when you least expect it. You and your passengers should know how to use all types of distress signaling devices. Seconds count during emergencies. Knowing the proper way to use the distress signaling devices on-board your vessel can help save lives.

The word "MAYDAY" is the international signal of distress. "MAYDAY" should only be used in emergency situations.

In emergency situations and when lives are in danger, you may need to use VHF-type two-way radios, cell phones and Emergency Position Indication Radio Beacons (EPIRBs). Knowing the proper use and operation of these communication devices is critical. You should know what channels to use and numbers to call. You should also know how to send an efficient and informative message about your emergency to ensure that proper help and assistance can be provided.

## Section 5

The VHF-type radio channel commonly used for communicating distress, safety and urgent calls is Channel 16.

To contact the USCG for an emergency while on the water, you should always use your on-board VHF-FM radio (Channel 16). Cell phones should only be used as a secondary means of communication. The number to call within the U.S. is 911.

For additional information on the safe and proper use of distress signaling devices and the safe and proper use of emergency communication equipment, contact your state and local authorities. Additional information can be found on the USCG website:

<http://www.uscgboating.org>

## CAPSIZING AND FLOODING

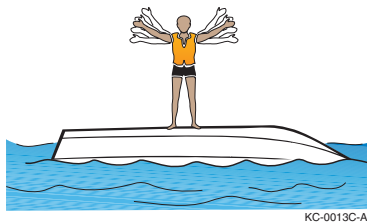

A boat may capsize or flood when you least expect it. Formulate a plan in advance in case of capsizing or flooding. Review the following guidelines:

- If the boat capsizes, locate all passengers and guide them to a safe flotation device or the forward hull if the boat is floating upside down.
- If possible, provide life jackets to all persons in the water and assess them for alertness and injuries.
- **STAY WITH THE BOAT!** Climb up on the hull and try to get assistance.
- Do not try to swim to shore as it can be farther than it appears.

If the boat starts to flood, slow the boat to a safe speed and stop as quickly as possible. Activate the bilge pump(s) immediately. Try and locate the cause of the flooding. If the cause is not readily apparent or easily corrected, head for shore or shallow water as quickly as possible and call for help.

## MAN OVERBOARD

If someone falls into the water unexpectedly, use the following guidelines. Every second counts toward preventing injury or death.

At the first sign that a person has fallen overboard, someone should loudly yell "Man overboard!" and state the position of the person in relation to the boat (Example: "Man overboard port!").

Set the engine(s) throttles at idle and place the gear controls in NEUTRAL position immediately.

Throw a Type IV PFD to the victim immediately if the PFD will be within reach of the victim. If the victim is too far away to throw a PFD, navigate back and throw the PFD from a safe distance. If a Type IV PFD is not readily available, any life jacket or floating device will suffice.

Someone in the boat must keep the victim in sight at all times. The captain should assign one person to watch the victim.

Carefully navigate back to the victim, staying at a safe distance and position to safely retrieve the victim.

Avoid going into the water to assist the victim unless there is absolutely no way to retrieve the victim safely from the boat and there is no chance of endangering others.

## RUNNING AGROUND

When a boat runs aground, the stop is usually abrupt. Because passengers are not secured to a seat, abruptly stopping a boat while in motion can cause serious personal injury or even death. First, turn off the engine(s) immediately, locate all passengers and attend to any injuries, calling for emergency assistance as needed. Then assess the damage to the boat and determine if there are any other immediate threats, such as water leaking into the boat, or fuel or flammable materials leaking into the water or inside the boat. Immediately call for assistance if threats exist that could endanger the safety of passengers.

If there are no immediate safety threats to passengers and the boat is not damaged, attempt to propel the boat away from the obstacle. If the engine or drive system has been damaged and the engine restarts, be aware of excessive vibrations or uncommon noises, which usually indicate damage to the drive system. It is not safe to proceed. Call for emergency or professional towing assistance immediately.

**WARNING! Use extreme caution when using tow lines and when connecting tow lines to cleats. Death or serious injury could occur when lines and/or cleats fail while they are under extreme tension.**

If the engine restarts and the boat can be navigated back safely to port, proceed slowly back to port and be ready to call for emergency assistance if needed. Even if the boat and engine appear to be in good operating condition after running aground, you should have the boat inspected by a qualified marine technician before returning it to service. Damage may have occurred that is not obvious to you as an operator.

### DANGEROUS WEATHER

When encountering or operating in dangerous or hazardous weather conditions, special precautions should be taken.

For additional information, see *Severe Weather* on page 6-1.

### ENGINE OR BOAT SYSTEM FAILURE

In the event of an engine or boat system failure and when not in immediate danger, try to troubleshoot or identify the problem before calling for assistance.

For additional information, see *Troubleshooting* on page 13-1.

### ACCIDENTS, COLLISIONS AND GIVING ASSISTANCE

A collision or accident may occur when you least expect it. Formulate a course of action in advance in case of a collision or accident. Keep in mind the following guidelines:

- If an accident or collision occurs involving your boat, locate all passengers first and verify and secure their safety. Check for injuries and provide all passengers with a flotation device.
- Once you have determined that your passengers are not in danger, provide assistance to passengers on the other boat.
- Immediately call for help and then assess the damage to the boats. Render necessary assistance to prevent further damage or personal injury.

The USCG requires the owner/operator of a boat involved in an accident to report the incident immediately to the proper marine law enforcement agency for the state in which the accident occurred.

If you witness or are aware of an accident or collision while boating, you must report it immediately and provide assistance.

If you see a distress signal or suspect a boat is in trouble, you must assume it is a real emergency and render assistance immediately. Once you have determined that a real emergency exists, call for help immediately and then provide assistance to all passengers to ensure their safety.

### TOWING ON THE WATER

If you encounter a situation where you are asked to tow or be towed for any reason, you should assess the situation and try to contact a professional towing service or other emergency assistance first. When encountering a boat in distress, always offer emergency or safety assistance and/or call for assistance for the distressed parties if necessary. Towing or being towed presents an increased risk of personal injury and boat damage.

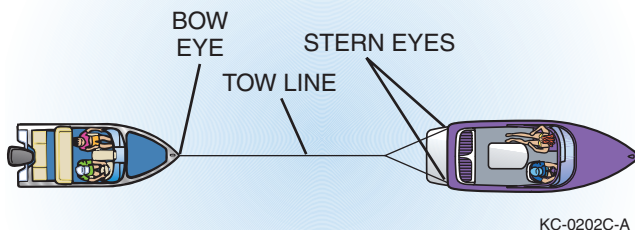

KC-0202C-A

**Figure 5-2**

**WARNING! Use extreme caution when using tow lines and when connecting tow lines to cleats. Death or serious injury could occur when lines and/or cleats fail while they are under extreme tension.**

Follow these guidelines when towing or being towed:

- Use extreme caution when throwing weighted lines to a boat in distress. When in rough seas, use a light throwing line with a weight secured on the throwing end and a heavier towing line secured to the other end.
- Never attempt to tow a boat larger or heavier than your own.
- Never attempt to tow a grounded, damaged or capsized boat.
- Use a tow line that is rated at least four times the gross weight of the boat being towed.
- Make sure tow lines are in good condition and are free of damage, cuts or abrasions.
- Attach a tow line to the bow eye on the disabled boat. Never attach a tow line to any point on the disabled boat other than the bow eye.
- Attach the tow line to the stern eyes of the tow boat. Wrap the tow line with chafing gear where it rubs against the boat or any corners.
- Leave at least two boat lengths between the boats for adequate movement.
- Never allow anyone to be in line with the tow line. If the line should break or pull free, dangerous recoil could occur, resulting in severe injury or death to anyone in its path.
- Adjust the tow line to match wave action. Keep the boats on the crest or in the trough of the waves at the same time. In protected, calm waters, shorten the line for better handling.
- Tow at moderate speed, allowing for adverse wind and wave conditions.
- Have the operator of the towed boat steer with you if possible.
- Have a person on the tow boat watch the disabled vehicle and, if necessary, be available to signal the operator of the disabled boat.

Check with local and state authorities prior to towing for additional regulations and restrictions on towing other boats or equipment.



**This Page Intentionally Left Blank**

*Section 6*

# OPERATING IN HAZARDOUS CONDITIONS

Before operating your boat, see *Safety* on page 3-1.

## SEVERE WEATHER

Getting caught in severe weather can be dangerous and even fatal. Check with local weather stations, the USCG or weather-service broadcasts (162.55 or 162.40 MHz) for the latest conditions. You should check the weather not only before you go out on the water, but also periodically while you are on the water. Consult the following websites for weather information:

- [www.weather.com](http://www.weather.com)
- [www.nws.noaa.gov](http://www.nws.noaa.gov)
- [www.navcen.uscg.gov](http://www.navcen.uscg.gov)

## Storm Conditions

Take the following precautions if you operate your boat in storm conditions:

- Have all occupants wear life jackets.
- Turn on navigation lights.
- Locate and have inclement weather gear and safety equipment ready.
- Mark or identify your position.
- Close all ports, stow all gear and secure any loose equipment on deck.
- Reduce speed and head for port or a safe, easily reachable place.
- Keep a lookout for debris and obstruction in the water.
- When possible, head into the waves at a 45 degree angle. Allowing high waves to strike the side of the boat may cause it to capsize or swamp.
- If you lose power, keep the boat headed into the waves by rigging a sea anchor off the bow.

### Fog Conditions

Avoid operating your boat in foggy weather, if possible. If you encounter fog conditions, return to port immediately. Also, take the following precautions:

- Reduce speed to a safe speed or idle.
- Take bearings and log your course and speed before the fog sets in. Use of a GPS is recommended.
- Have all occupants wear life jackets.
- Assign lookouts to the bow and stern to keep watch and listen.
- While navigating in fog, you must sound a five-second blast from your horn or whistle once every two minutes to alert other boaters of your position.
- If you determine that it is unsafe to continue navigating the boat, quickly find the best position to anchor. You must sound a five-second blast from your horn or whistle once every minute while anchored to alert other boaters of your position.

### Reduced Visibility

Natural environments and inclement weather can cause reduced visibility. Storm condition hazards can be compounded by reduced visibility while on the water. Always use common sense and take safety precautions if you are operating your boat in reduced visibility conditions.

### Cold Weather and Cold or Frozen Water Conditions

Avoid operating your boat in cold water or weather conditions, and never operate in frozen or icy waters. Operating in these conditions significantly increases the risk of serious injury or death. Boating in these conditions can lead to cold-water immersion, shock or hypothermia. Weather conditions may hinder emergency rescue or assistance, and cold weather poses potential problems for on-board equipment, as well as the engine. See the *Engine Operator's Manual* and the equipment manufacturer's instructions for operating in cold weather.

## WATER HAZARDS

Every waterway poses hazards that you should be aware of and avoid. These hazards include shallow water, tree stumps and sand bars. Ask local authorities and other boaters for information and consult a marine chart when boating on unfamiliar waters. As a boat operator, you should try to avoid all hazards, known and unknown.

## Dams and Spillways

The waterways around dams and spillways are extremely hazardous. Dams and spillways are subject to rapid water flow changes, and may have floating and sunken debris in the nearby water. These areas are often marked as restricted, and it is best to always stay clear of them.

## Aquatic Vegetation/Weeds

Operating in weeded areas can be extremely hazardous. Aquatic vegetation can be a threat to your boat's drive system. Vegetation and weeds can wrap around the propeller and drive unit, causing loss of propulsion and steering control. They may also restrict the engine water cooling intake, causing the engine to overheat. Avoid operating in or near vegetation. If you encounter any restriction because of vegetation, stop the engine. See the *Engine Operator's Manual* for recommendations for the removal of vegetation from the drive unit, propeller and water cooling intake ports. Be extremely careful and never get into the water when clearing the propeller. Stay out of the water in highly congested vegetative areas, which can severely restrict your mobility and create a life-threatening situation. *NOTICE: Vegetation can sometimes be removed by shifting to NEUTRAL, pausing a moment, then shifting to REVERSE to unwind the vegetation from the propeller.*

## Shallow Water Operation

Operating in shallow water presents a number of hazards. Sandbars in narrow inlets are constantly shifting, making it difficult to mark them with buoys. Sandbars are sometimes indicated by waves as they form into breakers when passing over the sandbar. In coastal areas, tides can affect water level as much as 30 feet (9 meters). Check with local marinas or Coast Guard stations for tide tables and current charts.

## RESTRICTED AREAS

Some waterways and areas are restricted. Always check with local, state and federal authorities to identify restricted areas. Because of the threat of terrorism, the USCG has implemented and will continue to enforce strict limits on watercraft near U.S. Navy and Coast Guard ships and other potential targets. For more information, contact the USCG or local authorities.

## MARKERS, WARNINGS AND ADVISORIES



KC-0015C-B

Find out from local authorities if hazards exist in areas where you intend to navigate, and know how these hazards are marked. You must also recognize flag designs that indicate hazards or activities that are present and keep well clear of those areas. Always watch for swimmers and stay clear of all swimming areas, marked or unmarked.

You should become familiar with navigation markers, which identify navigable routes and indicate water hazards. Always stay within marked boundaries and steer clear of hazards.

Distress flags and indicators are markers of potential emergencies and hazards. You should become familiar with these flags and indicators. Additionally, you should understand your responsibilities when operating at these times and in these areas.

DIVERS FLAG



USED BY RECREATIONAL DIVERS - INDICATES DIVER'S POSITION

ALPHA FLAG

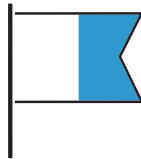

WORLDWIDE VESSELS ENGAGED IN DIVING OPERATIONS - DOES NOT INDICATE DIVER'S POSITION

DISTRESS FLAG









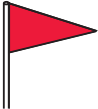

INDICATES FELLOW BOATER IS IN NEED OF ASSISTANCE

KC-0017C-A

**Figure 6-1**

Storm warning advisory flags and indicators alert boaters to impending weather conditions. You should become familiar with these flags and indicators and understand the potential hazards associated with operating in these conditions.

# Operating in Hazardous Conditions

DAYTIME WARNING	DESCRIPTION	NIGHTTIME WARNING	DAYTIME WARNING	DESCRIPTION	NIGHTTIME WARNING
	<b>Small Craft Advisory</b> - Winds greater than 18 knots, sustained for two hours or more or hazardous wave conditions. Following a storm, hazardous wave conditions can persist long after the high winds have subsided.			<b>Storm Warning</b> - Sustained winds of 48 knots or greater.	
	<b>Gale Warning</b> - Sustained winds (2 or more hours) of 34-47 knots.			<b>Hurricane Warning</b> - Forecast winds of 64 knots and above. Displayed only in connection with a hurricane.	

KC-0018C-B

**Figure 6-2**

**This Page Intentionally Left Blank**

## Section 7

# NAVIGATION RULES AND AIDS

Before operating your boat, see *Safety on page 3-1*.

The following information outlines basic navigational rules. Boating regulations are enforced by USCG, state and local authorities. You are subject to marine navigation regulations for both federal and state waterways. For more information, contact the USCG, state and local marine authorities. The navigational rules for U.S. waterways can be found in the “Navigational Rules” publication. This publication can be found at most marine supply stores, or you may contact the USCG or visit [www.navcen.uscg.gov/mwv/NavRules](http://www.navcen.uscg.gov/mwv/NavRules) to view or download the publication.

Any boat 39 feet (12 meters) or longer in length must have a copy of the “Navigational Rules” publication on-board at all times. Failure to have this document on-board can result in penalties and/or fines.

## AUDIBLE DISTRESS SIGNALS

It is not necessary to sound a signal every time a boat is nearby. Boat operators should always signal their intention, using a whistle, horn or bell, to avoid potentially confusing or hazardous situations. Privileged boat operators customarily signal first, then the yielding boat operators return the same signal to acknowledge they understand and will comply. Use the danger signal (five or more short, rapid blasts) if intent is not clear.

Use the following signal blasts early enough so other boaters notice and understand them:

Audible Distress Signal	Definition
One long blast	Warning signal (coming out of slip or passing astern)
One short blast	Pass on port side
Two short blasts	Pass on starboard side
Three short blasts	Engine(s) in reverse
Five or more short blasts	Danger signal



### RIGHT-OF-WAY

Boats with less maneuverability have right-of-way over more agile boats. You must stay clear of a boat with right-of-way. Examples of boats with right-of-way are:

- Boats aground or not under command
- Boats with restricted maneuverability
- Boats engaged in fishing
- Non-motor boats (having no power propulsion), i.e., rowboats, paddle boats, canoes and sailboats

Small pleasure craft must yield right-of-way to large commercial boats in narrow channels. A boat with right-of-way is sometimes referred to as the privileged boat.

### The General Prudential Rule

The general prudential rule regarding right-of-way is if a collision appears unavoidable, neither boat has right-of-way. Both boats must act to avoid collision.

### NAVIGATIONAL LIGHTS & NIGHT OPERATION

Navigational lights alert other boats to your presence and course, especially when operating at night or in restricted visibility conditions.

Regulations require that navigational lights be clearly lit and properly displayed at all times between sunset and sunrise, and always when operating in reduced visibility. Where applicable, lights must appear on the sides, stern, masthead and all-around positions.

All navigational rules apply at night, but speed is restricted on many waterways. Night boaters should operate at a slow, safe speed and stay clear of all boats, regardless of which boat has right-of-way.

Protect your night vision by avoiding bright lights. If possible, have a passenger help keep watch for other boats, water hazards and aids to navigation.

The size, speed and direction of other vessels are determined at night by white, green and red running lights.

- A green light indicates the starboard side of the boat. Generally, if you see a green light on another boat, you have the right-of-way and should hold your course.
- A red light indicates the port side of the boat. Generally, if you see a red light on another boat, they have right-of-way and you should yield your course.

## SPEED

The operator is responsible for maintaining your boat under control at a safe speed. Many state and local boating authorities enforce speed limits. Regulations may vary from state to state. Contact your local and state boating authorities for specific information.

## WAKE

You, as the operator, are responsible for the wake your boat creates. You should always be alert for NO WAKE zones and be courteous of others while boating. Excessive and unexpected wakes can cause dangerous and even life-threatening situations. Regulations may vary from state to state. Contact your local and state boating authorities for specific information, as you may be responsible for any damage or injury your wake causes.

## OVERTAKING / PASSING

The boat overtaking or passing must yield right-of-way to the boat being passed. The overtaking boat must make any adjustments necessary to keep out of the way of the boat being passed. The boat being passed has the right-of-way and should hold its course and speed.

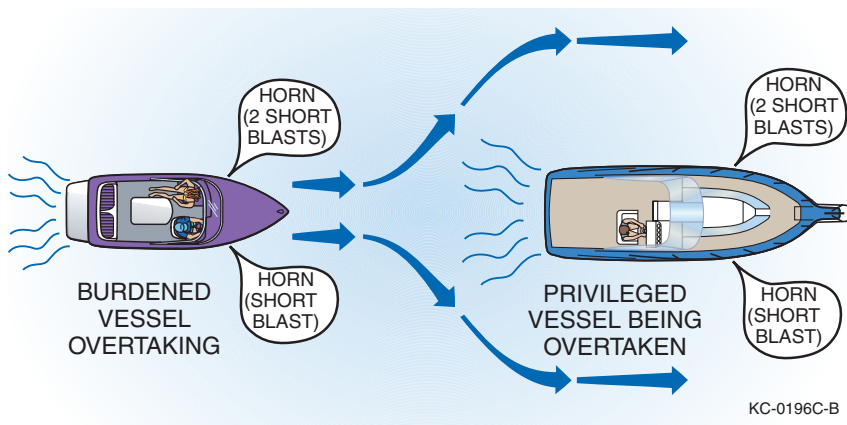

Figure 7-1

# MEETING HEAD-ON

When two boats meet head-on, neither boat has the right-of-way. Both boats should decrease speed, turn to the right and pass port to port. If, however, both boats are on the left side of a channel, each vessel should sound two short horn blasts and pass starboard to starboard.

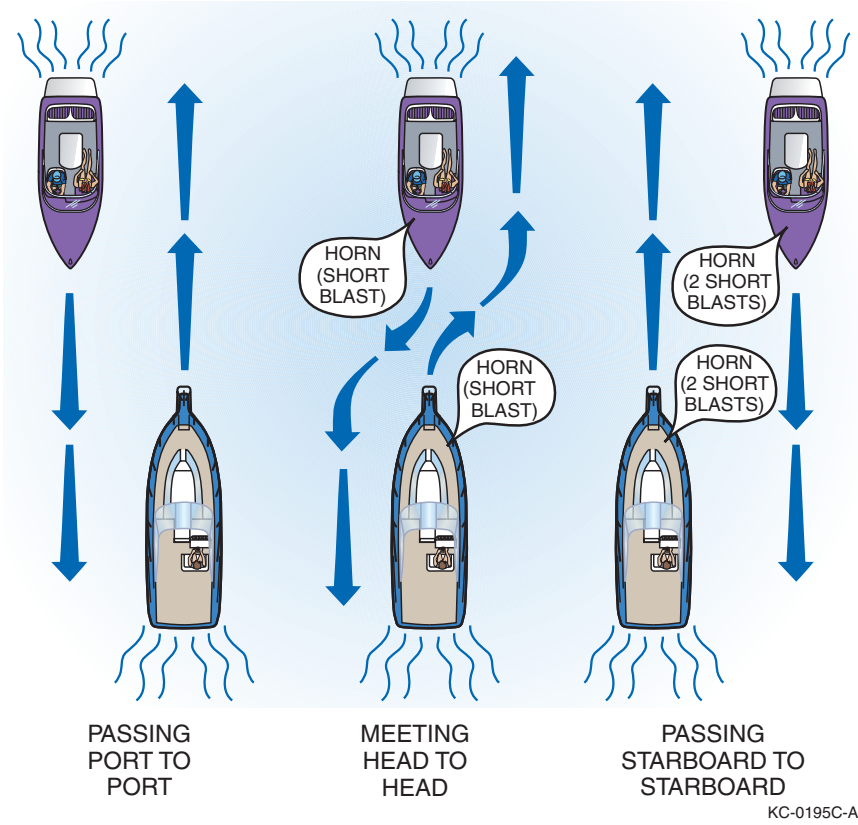
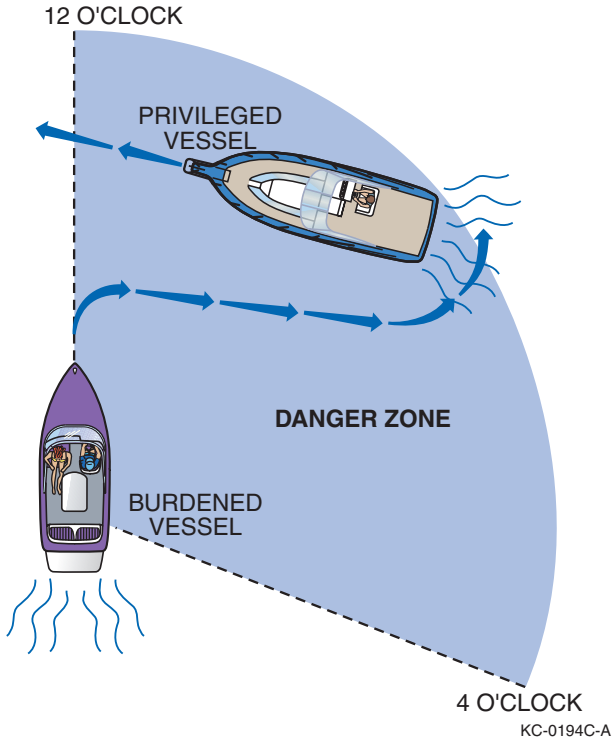

Figure 7-2

## CROSSING

In crossing situations, the boat to the right from the 12 o'clock to the 4 o'clock position has the right-of-way and must hold course and speed. The boat without right-of-way must yield and pass to the stern of the privileged boat. Boats going up and down a river have the right-of-way over boats crossing the river.



**Figure 7-3**

## AIDS TO NAVIGATION

Learn to recognize the different buoys and day markers; they are the signpost of the waterways. The United States Aids to Navigation System (USATONS) is the primary marking system used on inland water, coastal waters and rivers. This system is maintained by the USCG.

Navigational aids are designed and placed accordingly to help you navigate safely on the water. Learn to recognize the different buoys and day markers.

The following information is based on the United States Aids to Navigation System (USATONS). For further information, contact the USCG and state and local marine authorities. Also visit [www.uscg.org](http://www.uscg.org) for buoyage system information.

The United States Aids to Navigation System (USATONS) uses buoys, beacons and minor lights as markers.

NEVER tie or anchor to a navigational aid. This action is unlawful and dangerous to you, your boat and other boaters.

NEVER move or damage a navigational aid. This action is unlawful and dangerous for other boaters.

### Buoys

Most anchored floating markers are generally referred to as buoys. Buoys have many uses and color schemes, and can vary in size and shape. The most commonly used buoy colors are white, red, green, yellow and black. Buoys may be unlighted or lighted. Some are audible; others have both an audible and a visual signal. Lights, bells and horns on buoys aid in night boating or poor visibility conditions. Buoys with unique light-flashing characteristics are identified on nautical charts with the specific flashing pattern.

Become familiar with the specific buoys used in the waters where you are boating. Contact local authorities for specific information and/or navigational aid charts for your waterways.

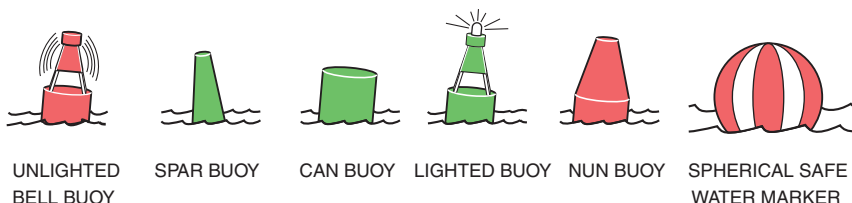

KC-0052C-B

**Figure 7-4**

## Mooring Buoys

The only buoys you are permitted to moor to are mooring buoys. Mooring buoys are white with a blue horizontal stripe. Mooring to a navigation buoy, regulatory markers or lateral markers is illegal.

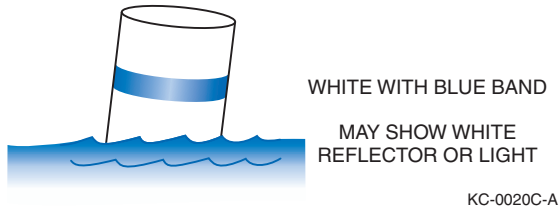

**Figure 7-5**

## Daymarks / Dayboards

Daymarks or dayboards are fixed visual markers in the water. The markers are commonly attached to a post or piling and are sometimes accompanied by a light. Daymarks are either red or green and are usually triangular- or square-shaped, though their shapes can vary. Daymarks often display numbers, which act as navigation guides. Red daymarks are usually triangular and sometimes show an odd number. Green daymarks are usually square and sometimes show an even number. The numbers on the markers are sequential and increase from seaward.

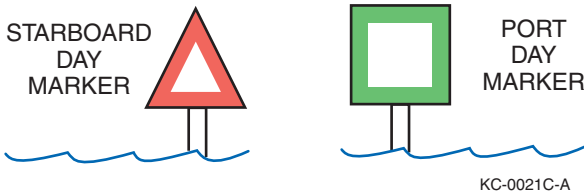

**Figure 7-6**

## Lights and Lighted Structures

Maneuvering a boat at night can be dangerous and confusing. To aid boaters with navigation and to warn of hazards, the USCG and state and local authorities maintain a variety of light structures. Some light structures are equipped with radio beacons, radar reflectors and/or fog signals.

### Range Lights

Range lights are usually visible in one direction and help a boat operator navigate safely. Steering a course to keep range lights arranged in a line (one on top of the other) will help guide a boat through a channel.

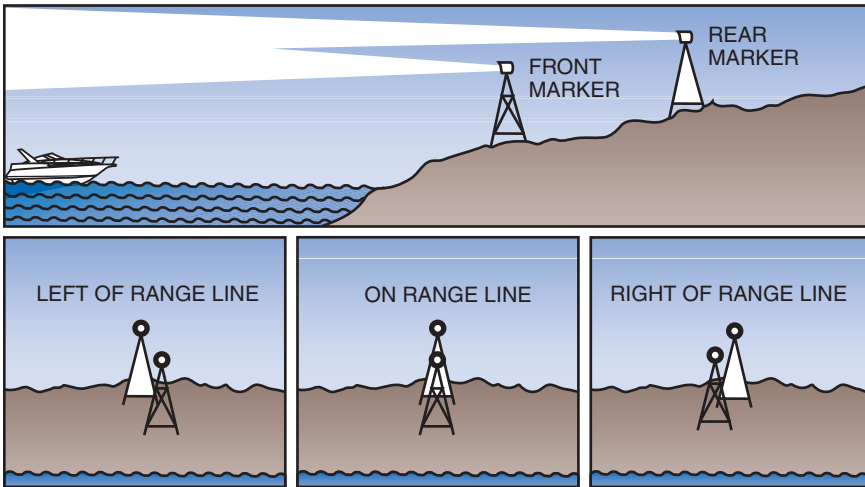

KC-0022C-A

**Figure 7-7**

### Minor Lights

Minor lights are colored according to the buoyage marking system in use. They are similar to lighted buoys, except they are usually higher and on more stable platforms to increase visibility. Most minor lights are part of a series to mark a channel, river, or harbor and fairways.

## Lighthouses

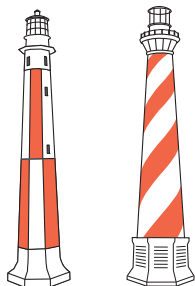

KC-0023C-B

Lighthouses can be found at harbor entrances, prominent headlands, isolated danger areas and along the coasts. These striped or patterned structures have unique flashing signals, which help boaters identify them.

## Markers

Seven (7) types of markers are used to assist the boat operator:

- Range
- Special
- Regulatory
- Safe Water
- Lateral
- Preferred Channel
- Isolated Danger

### Range Markers

Range markers have many color schemes, may have numbers or letters and may be lighted or unlighted. They are placed in pairs within close distance of each other. They are commonly used in channels to guide boats safely through the center or safe line of navigation. Keep range markers visually in line with each other while navigating the waterway to avoid obstacles or other invisible dangers.

### Special Markers

Special markers are yellow and come in various styles and shapes. Lighted and unlighted daymarks and buoys vary in function. Many are used to display information and navigational direction rules. The most common special markers are those used in intercoastal waterways. Contact your state and local authorities for more information on special markers used in your boating area.



## Regulatory Markers

Regulatory markers are used to display information or indicate danger. Regulatory markers can be fixed visual markers or anchored floating buoys.

Fixed visual markers are usually white with orange geometric shapes that display information. Anchored floating buoys are white cylinder-shaped buoys with orange bands at the top and orange geometric shapes that may display information.

Following are the various orange geometric shapes used on these markers:

- Diamond – Indicates danger
- Diamond with cross marks inside – Indicates that a boater should keep away
- Circle – Indicates a controlled area or speed limit
- Square – Displays important information

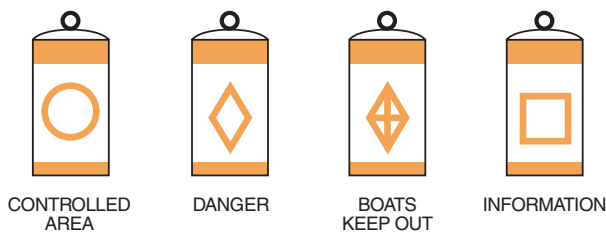

KC-0244C-A

**Figure 7-8**

## Lateral Markers

Lateral markers are used to mark the sides of navigable channels. They can be buoys, daymarks or minor lights, and are red and green in color. They can be lighted or unlighted and may or may not have numbers.

The basic nautical rule of lateral markers is the phrase “Red, Right, Returning.”

The term “sea” generally refers to the ocean or a large body of water. “Seaward” refers to traveling from the sea or a large body of water inland or to a smaller body of water of water.

When traveling seaward – keep red markers to your port (left) and green markers to your starboard (right).

When returning from seaward – keep red markers to your starboard (right) and green markers to your port (left).

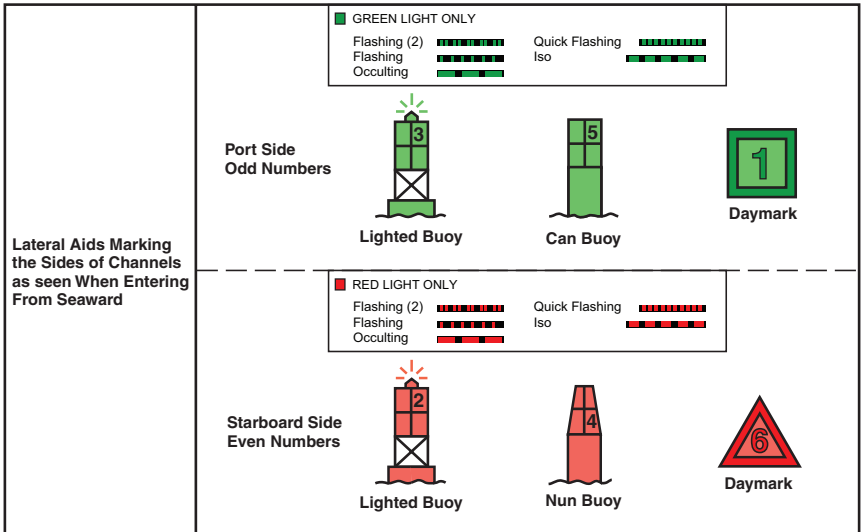

KC-0054C-A

**Figure 7-9**

## Safe Water Markers

Fairways and mid-channels may be marked with safe water marks or buoys. These marks indicate safe water all around. Safe water marks are red and white with vertical stripes, and are round or have a red spherical top mark.

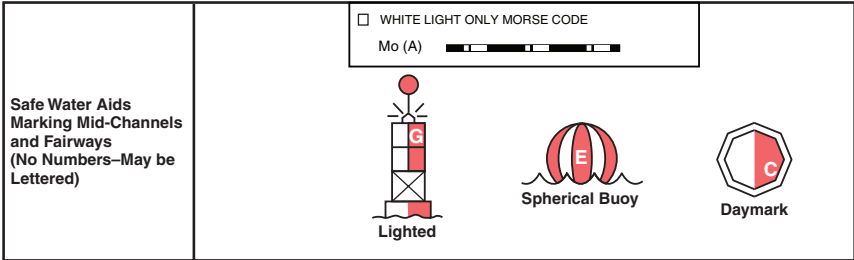

KC-0055C-A

Figure 7-10

## Preferred Channel Markers

Obstructions, channel junctions and preferred channels are marked with red and green horizontally striped can and nun-style buoys. The top band color indicates how the marker should be used. These markers should be used in the same manner as lateral markers to follow preferred channels.

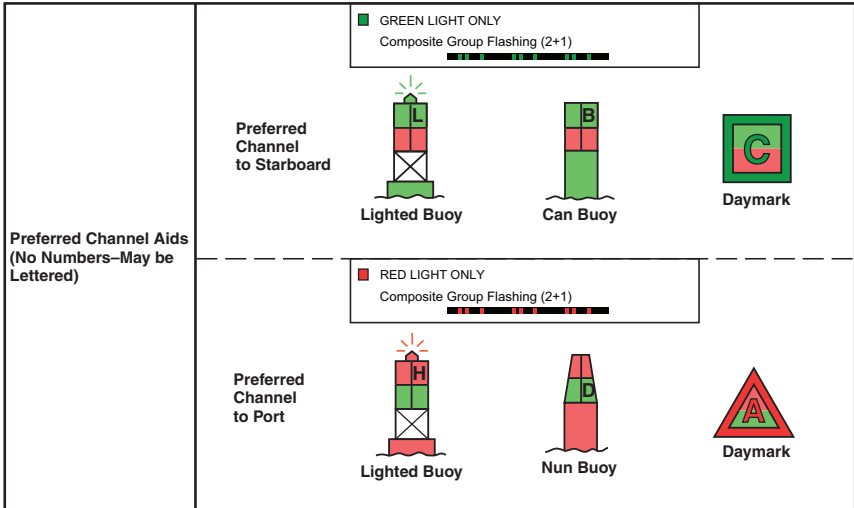

KC-0056C-A

Figure 7-11

## Isolated Danger Markers

Isolated danger markers indicate an isolated danger which may be passed on all sides. These markers are black with one or more broad horizontal red bands and are equipped with a top mark of two black spheres, one above the other. On inland waters, a buoy with alternating vertical black and white stripes may be used to indicate that an obstruction or other danger exists between the buoy and the nearest shore. Do not pass between the buoy and the shore.

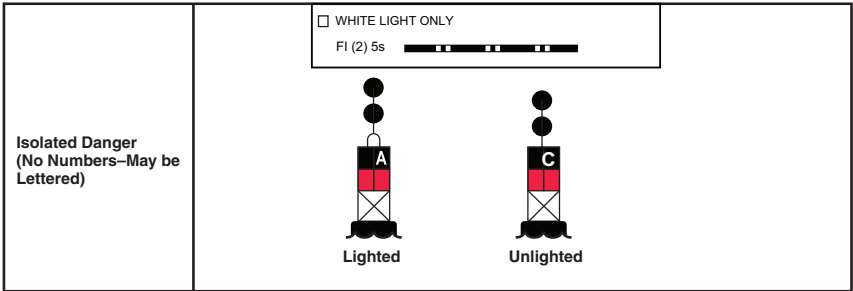

KC-0057C-A

**Figure 7-12**

## Other Special Signs And Markers

Various signs and markers are used throughout U.S. waterways for different purposes. In Florida special signs are used to warn of “manatee” areas. These signs help to control speed and/or restrict areas from boating to conserve this endangered species. As a boat owner and operator, you should be aware of special information and markers on the waterways. Contact your state and local authorities for more information on local restricted or controlled areas and their markers.

**This Page Intentionally Left Blank**

Section 8

# OPERATING YOUR BOAT

Before operating your boat, see *Safety* on page 3-1.

## SAFETY PRECAUTIONS



**WARNING**

These safety messages describe hazardous situations which, if not avoided, *could* result in death or serious injury.

### **Runaway Boat Hazard**

Certain actions can cause you to lose control of your boat.

- When accelerating the boat in the forward direction, the bow can rise and restrict visibility. Observe for obstacles and people before accelerating.
- If you lose control of the boat, pull back on the throttle.

## BEFORE GETTING UNDER WAY

### **Safety Equipment**

Federal and local laws require certain safety equipment to be on-board at all times. Responsible boaters carry additional equipment in case of emergency.

### **Filing a Float Plan**

Complete a float plan before departure and leave it with a reliable person who is aware of your intentions while on the water. In case of emergency or if you do not return as planned, this information can be helpful to the USCG or others in rescuing or contacting you. For more information on float plans or to download a float plan form, visit the U.S. Coast Guard Auxiliary website at <http://www.floatplan.uscgaux.info>.

### Pre-Departure Safety Checklist

The following checks are essential to safe boating and must be performed before starting the engine or getting under way. Perform these checks every time you operate your boat so they become routine.

Never launch the boat or leave the safety of the dock if any problem is found during the pre-departure safety check. A problem could lead to an accident during the outing, causing severe injury or death. Have any problems corrected before proceeding.

- Check the current and forecasted weather reports, as well as wind and water conditions.
- Make sure the operator is qualified and does not use drugs or alcohol while at the helm.
- Make sure all required safety equipment is on-board.
- Make all passengers aware of safety procedures.
- File a float plan.
- Have all required documents on-board.
- Have all maps or navigational charts for the intended destination on-board.
- Be sure all passengers are properly seated.
- Be sure the boat is not overloaded.
- Check the engine emergency stop switch lanyard for proper installation and operation.
- Be sure the fire extinguisher is fully charged.
- Have plenty of emergency food and water on-board.
- Be sure all required equipment is on-board (mooring lines, anchor lines, tool kit, etc.).
- Be sure you have enough fuel for the return trip.
- Be sure no person or obstacle is near the propeller.
- Check that all required maintenance has been performed.

#### Check the following engine and boat related items:

- Check that throttle/shift control is in the NEUTRAL position.
- Inspect the steering, throttle, and shift cables for kinks, wear and interference with other components.
- Check the engine cooling water intake pickup and strainer for blockage.
- Check that batteries are fully charged and the battery terminals are clean and tight.
- Check the electrical systems and navigation lights for proper operation.
- Check bilge drain plugs for proper installation.
- Be sure all water has been pumped from the bilge area.
- Check the bilge blower for proper operation, and be sure no fumes are present in the bilge area.

- Check that no fuel, oil or water is leaking or has leaked into the bilge compartment.
- Check all hoses and connections for leakage and damage.
- Check the hull and propeller for damage.
- Check the V-drive fluid level.
- Check the engine belts for looseness or damage.
- Inspect the exhaust system for leaks.
- Inspect the propeller shaft seal for excessive water entry.
- Inspect the drive train for loose or missing hardware.

## Boarding

Helpful guidelines when boarding a boat:

- Always step, rather than jump, into a boat.
- Avoid stepping on fiberglass or other potentially slippery surfaces.
- Always board one person at a time.
- Never board while carrying gear. Set the gear on the dock, board the boat and then pick up the gear.
- Never use the engine unit as a boarding ramp.
- It is courteous to always ask for permission to board so the owner/operator is aware of your presence on the boat.

## Boat Loading

The safety and performance of your boat depends on load, weight and the distribution of each.

The person/load capacity is determined by the USCG. A capacity plate is usually located within clear visibility of the boat operator or helm area. The capacity plate indicates limits for loading the boat, which are enforceable by law.

**WARNING! NEVER exceed the USCG certified maximum capacities under any circumstances. Exceeding the limitations stated on the capacity plate can cause the boat to sink or the passengers and/or operator to drown, resulting in death or serious injury.**

- Passengers should board one at a time and should distribute themselves to maintain equal buoyancy of the boat.
- Distribute weight equally from port to starboard and fore to aft. The shifting of weight may be required when under way to maintain an efficient hull running attitude for optimum performance.
- Stow and secure all loose gear in storage areas to prevent load shifting.
- Do not stow gear on top of safety equipment; safety equipment must be quickly accessible.



# Section 8

- In adverse weather, reduce the load in the boat. Person and load capacity ratings are calculated for normal boating conditions.

Be sure all passengers are properly seated inside the boat and not riding on the bow, gunwale or rear platform while under way. Passengers riding in the bow should exercise extreme caution. During rough water operation, passengers in the bow should move to the aft passenger seats.

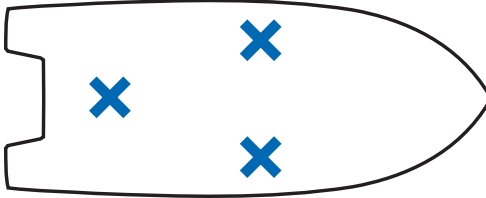

PROPER DISTRIBUTION

KC-0035-A

**Figure 8-1**

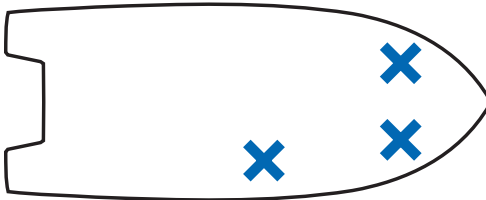

IMPROPER DISTRIBUTION (BOW HEAVY)

KC-0036-A

**Figure 8-2**

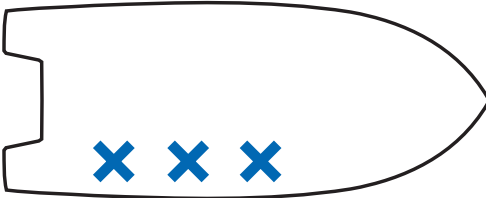

IMPROPER DISTRIBUTION  
(STARBOARD HEAVY)

KC-0037-A

**Figure 8-3**

## Fuel Management

Use the “one-third” rule for fuel management. Use one-third of the fuel to reach your destination, one-third to return and one-third as reserve fuel.

## Fueling

The fuel filler is either located in the aft area or in front of the starboard windshield area. The fuel tank is equipped with an antisiphon valve that operates automatically to prevent fuel from draining from the tank in the event of a leak in the fuel system.

Gasoline fumes are heavier than air and will sink to the lowest part of your boat, such as the bilge. Always evacuate fumes with the bilge blower (if equipped) before attempting to start the engine.

*NOTICE: To prevent unwarranted engine damage, see your Engine Operator's Manual for manufacturer-recommended fuel and oil specifications.*

When refueling, observe the following:

- Have a proper and charged fire extinguisher ready. **WARNING! Gasoline is extremely flammable and highly explosive under certain conditions. See Safety on page 3-1 for more details.**
- Secure the boat to the dock.
- Stop all engines, motors and fans before refueling.
- Never smoke or allow open flames or sparks within 50 feet (15 meters) of the fueling area.
- Avoid spills and know how much fuel is already in the tank before adding fuel. Wipe up any spills immediately.
- Always fill fuel tanks slowly. Be aware that if the boat's attitude changes while floating, the fuel level and position change in the tank, which could cause spillage.
- Never overfill the fuel tanks.
- Always allow space (at least 6%) for expansion of fuel in the fuel tank.
- Always be sure you are filling the proper tank; some deck filler plates appear similar to the fuel tank.
- Never pump fuel into an unapproved container.
- Use only fuel approved by the engine manufacturer.
- Check for fuel leaks.
- Refuel only at safe and approved filling stations such as marina fuel docks or automotive fuel stations. Approved venues have safeguards in place to lessen the likelihood of static discharge.
- Read and follow all warnings on the pump or in the vicinity of the pump.
- Maintain contact between the fuel nozzle and the fill pipe at all times, before and during refueling, to prevent an electrostatic spark.

## Section 8

- Be aware of the fuel tank vent to avoid splash-back and fumes during refueling.
- Never reenter your vehicle while refueling on land and towing your boat. Getting into and out of your vehicle might build up a static charge that could ignite the fumes at the fill pipe.
- If a fire occurs, do not panic, and do not remove the nozzle from the gas tank.
- Evacuate all passengers from the vehicle and refueling area, and immediately alert station attendants so they can use the emergency shutoff and fire extinguisher.
- If you are unable to pump fuel at a reasonable speed, check the fuel tank vent for restrictions.

After refueling, observe the following:

The first time you fill your boat's fuel tank(s) and after each refueling, check the entire fuel system for leaks and/or damaged parts. Leaks and/or damaged parts must be repaired and the area ventilated to remove explosive fumes.

- Close the fill cap(s) securely.
- Wipe up any spilled fuel completely. Dispose of the rags properly.
- Check for fuel vapors before starting the engine.
- Operate the bilge blower (if equipped) before the engine is started, for a minimum of four minutes.

## GETTING UNDER WAY

The following basic boat maneuvering and operation principles do not cover all conditions or situations you may encounter during operation. You and anyone else operating the boat should seek certified instruction from local boating authorities.

Always advise all passengers on-board of your steering, stopping and accelerating intentions to avoid personal injury or even death.

Make sure all passengers are properly seated and not riding on the bow, gunwale or rear platform while under way. Passengers riding in the bow should exercise extreme caution. During rough water operation, passengers in the bow should move to the aft passenger seats.

## Starting

The following information is intended as a basic guideline only and may not apply to your specific engine or controls. See the *Engine Operator's Manual* or control manufacturer's information for instructions on starting and operating the engine, adjustments and maintenance.

- Secure the boat to the dock before starting the engine.
- Check that the throttle is in the NEUTRAL position.
- Turn the battery selector switch to the appropriate ON position (if equipped).

- Operate the bilge blower long enough (minimum of four minutes) to fully evacuate the engine and bilge compartments of explosive fumes.
- Attach the engine emergency stop switch lanyard to the boat operator.
- Check that all passengers are seated properly.
- Start the engine.

## Stopping

A boat does not have brakes. Controlling your boat to a stop and while stopped are important skills that must be learned. Reverse thrust is commonly used to slow and stop a boat. The continued momentum of a boat will vary according to the boat design, load and speed. You must also consider and learn to compensate for the effects of wind and current. Stopping in wind or water currents is difficult and requires skill to be able to anticipate and compensate for these effects.

- To stop or slow forward motion, always gradually return the throttle(s) to the slow IDLE position, pause and shift into NEUTRAL, then pause and shift into REVERSE. **WARNING! Always gradually return the throttle(s) to the slow IDLE position. Failure to do so can cause loss of boat control, personal injury or death, and engine or drive system damage.**
- If the boat has been driven for a long period of time at high speed, allow the engine a two-to three-minute cool-down period at low idle in NEUTRAL.
- Turn the ignition key to the OFF position. *NOTICE: Never pull the lanyard from the engine emergency stop switch for normal shutdown. Doing so may impair your ability to restart the engine quickly.*
- Avoid collisions; at high speeds your boat will require more time and distance to stop or slow.

### Steering

Steering a boat is very different from steering an automobile. Steering and maneuvering a boat is far more difficult and requires time and practice to master.

When steering a boat, it is important to understand the causes and effects of turning. Since both thrust and steering are at the stern of the boat, the stern will push away from the direction the steering wheel (helm) is turned. The boat seems to skid across the water while turning, which feels very different from an automobile making a turn.

Steering in reverse has its own challenges. You should practice forward and reverse steering to gain comfort and to feel in control of your boat in any steering situation. All boats pull to starboard when in reverse. Turning the rudder hard to port will not always cause the boat to turn to port. Forward thrust may be required with the rudder turned hard starboard to get the stern moving to port and then shift into reverse to turn to port.

You should also be prepared for wind and current while steering your boat. Steering in wind or water currents is difficult and requires skill to be able to anticipate and compensate for these effects.

Rotational thrust of the propeller is an aspect most propeller-driven boats share and needs to be compensated for at slow speeds. During rotational thrust, torque is transmitted to the helm and may cause the boat to drift either port or starboard when moving forward at a slow speed. Rotational thrust usually goes unnoticed at high speeds. While moving forward at a slow speed, constant helm corrections may be necessary to maintain a straight course.

All rudders are designed to help reduce steering effort by pulling starboard (right-hand pull) at all speeds. Some boats may be equipped with an adjustable rudder tab, that can be used to tune the amount of steering torque felt at the helm.

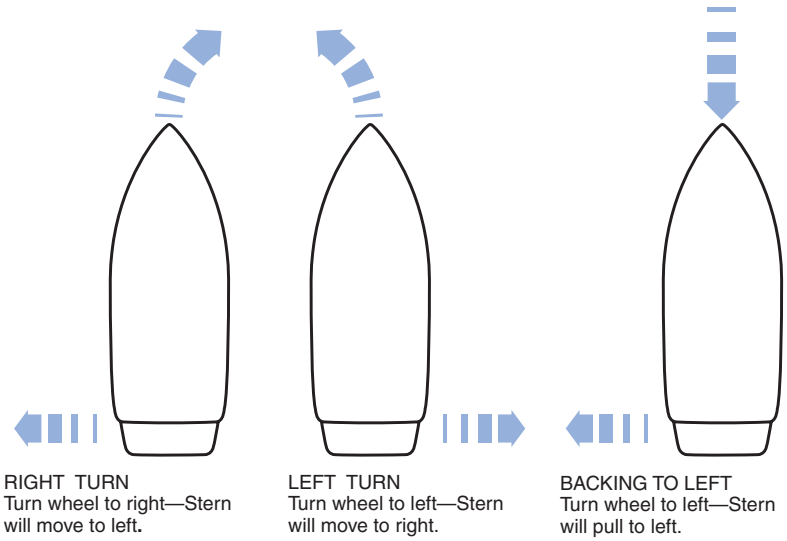

KC-0199-A

**Figure 8-4**

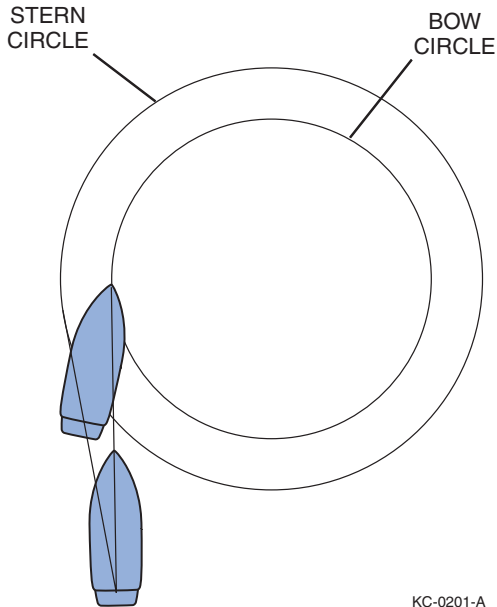

KC-0201-A

**Figure 8-5**

### Shifting

The following information is a basic guideline only and may not apply to your specific shift control. See the *Engine Operator's Manual* or control manufacturer's information for the shift control operation, adjustment and maintenance.

- Most throttle and shift controls have a neutral detent locking lever that must be released before shifting from NEUTRAL.
- Always pause in NEUTRAL before shifting from FORWARD to REVERSE, or REVERSE to FORWARD. Most throttle and shift controls have a detent position for NEUTRAL, FORWARD and REVERSE engagement positions. These detent positions are important; when shifting into and out of gear, always pause in these positions.
- Never shift into REVERSE while the boat is in FORWARD gear when traveling at a high speed.
- Always keep the shift control clean and clear of obstructions.

### Accelerating and Running Under Way

You should thoroughly understand your boat's equipment and controls in order to drive and control your boat in a forward direction at all speeds and in all conditions. Learning to drive and control your boat can be challenging; you should take this matter seriously and spend plenty of time practicing. **WARNING! When accelerating the boat in the forward direction, the bow can rise and restrict visibility.**

The phrase "on plane" is commonly used when referring to the running angle of a boat in forward motion. When a boat is "on plane" its hull is usually running level or almost level with the water's surface, which is considered level. The level "plane" of the water's surface is the most efficient angle to run in. This basically means that the boat is running on top of the water and not plowing through it.

Factors to consider when accelerating a boat forward and running at the most efficient planing angle are:

- Boat design
- Hull type and condition
- Boat load and distribution of weight
- Engine capability and condition
- Propeller type, size and condition
- Power trim equipment and condition (if equipped)

Because all boats are different and vary in design, purpose and load, planing angles and characteristics will vary among all boats. You should seek qualified assistance to help you become familiar with your boat's characteristics.

The following guidelines provide a basic understanding of forward acceleration and operating on plane while under way:

- Always look in front of and around you before proceeding. Avoid collisions before accelerating; be aware and stay clear of people and obstacles in the water.
- Always advise all passengers on-board of your intention to accelerate and get under way.
- Stow and secure all loose gear.
- Make sure the engine emergency stop switch lanyard is connected to your person.
- If equipped, adjust the boat's trim equipment.
- Shift from NEUTRAL into FORWARD detent idle position.
- Adjust steering to the direction of travel.
- Using a controlled and constant motion, move the throttle control forward.  
**WARNING! When accelerating forward, the bow can rise and restrict visibility. Never remove your hand from the helm.**
- As the boat begins to move, the bow will rise and the boat will tend to plow through the water. As acceleration increases, the boat should begin to plane or level out within a few seconds. If the boat will not plane to a near-level position, slowly reduce the throttle back to the FORWARD detent idle position. Recheck your load and trim equipment position to determine the cause.
- Once the boat is on plane, the steering torque should be reduced; however, you should never remove your hands from the helm while under way. While running at a planed position, you will notice greater throttle response and steering control as you continue to accelerate or achieve the most comfortable and safe speed for the conditions. If equipped, you can achieve better performance, control and running efficiency using the boat's trim equipment,
- Be aware of the wake you create and anticipate the effect it will have on others. During acceleration, deceleration and at speeds other than on plane, a heavy wake is usually created. You are responsible for your boat's wake and any damage or injury it causes.
- Obey no-wake areas and speed-controlled areas.
- Stay clear of or at a safe distance from other boats.
- Avoid collisions; at high speeds your boat will require more time and distance to stop or slow.

## Checks During and After Operation

- Check gauges frequently for signs of abnormal conditions.
- Check that controls operate smoothly.
- Check for excessive vibration.



### Docking

Practice leaving and approaching the dock to become familiar with the procedures.

#### Helpful guidelines when departing from the dock:

- Make sure you have sufficient space to maneuver your boat away from the dock, other boats and any other obstacles that may hinder your departure.
- Always allow sufficient clearance to the stern for the engine to clear any obstructions.
- Be aware of other boat traffic, wind and water conditions before departing.
- Make sure the engine(s) is started and you have boat movement under control before casting off any mooring lines.
- Always proceed slowly when departing from a dock.

#### Helpful guidelines when docking:

- Make sure you have sufficient space to maneuver your boat around the dock, other boats and any other obstacles that may hinder your approach.
- Be aware of other boat traffic, wind and water conditions on your approach.
- Always approach from a direction against the wind or current.
- When possible, approach slowly from a 45 degree angle and then steer parallel to the dock.
- Have fenders, mooring lines and assistance ready. **WARNING! Never use your hand, arm or other part of your body to attempt to keep the boat from hitting the dock. The boat could push against the dock, causing severe injury.**
- If possible, throw a mooring line to a person on the dock and have that person secure the bow. With the bow secure, swing the stern in with the engine, or pull it in using a boat hook or the stern line.
- Tie off the bow and then the stern.

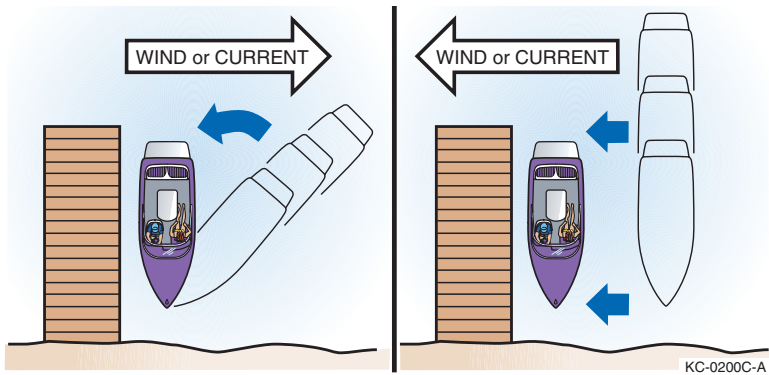

**Figure 8-6**

## Mooring

**NOTICE:** It is not recommended to leave your boat in the water for extended periods of time. Extended mooring may cause hull surfaces to discolor and/or blister. Damage caused from this type of exposure is not covered under the Centurion boat warranty. If extended mooring is necessary, consider using a high quality bottom paint for additional protection.

Because mooring configurations vary, you should consult with other experienced boaters or qualified boating authorities for recommendations on properly mooring your boat. Always moor your boat securely to prevent personal injury or property damage.

Helpful guidelines when mooring:

- Each mooring line should be of the appropriate strength, material and type to safely secure your boat when moored.
- Each mooring line should be longer than the length of your boat.
- Use bow and stern mooring lines, as well as spring lines, for additional security.
- Use fenders to protect the boat from damage.
- When possible, tie up with the bow facing into the wind or current.
- Never attach a mooring line to a point or part of the boat that is not designed to withstand the stress and the weight of the boat.
- Only use the bow eye, stern eyes and other cleats or attachment points that have been approved for mooring.
- If you plan on mooring the boat for a long period of time, use chafing protectors on lines to protect the boat's finish.
- Leave some slack in the lines to allow for wave movement or tidal action if applicable.

## Anchors and Anchoring

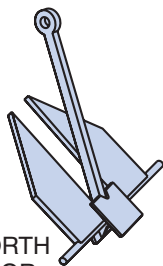

DANFORTH  
ANCHOR

KC-0042-A

Anchors are available for various applications and come in many sizes, types and shapes. Boat weight and size are primary factors in choosing an anchor. When selecting an anchor, consult other qualified boaters or local marine authorities.

Anchor line (rode) is constructed from various materials and is available in many diameters and types. Consult with your local marine supply store for a recommendation of appropriate lines for your boat anchor and application. For most applications, anchor line length should be at least seven times longer than the depth of the water in which you are anchoring. Always have plenty of additional anchor line on-board. **WARNING! ALWAYS anchor from the bow; NEVER anchor from the stern. A small amount of current will make the boat unsteady. A strong current can pull a boat, anchored by the stern, under the water and keep it there.**

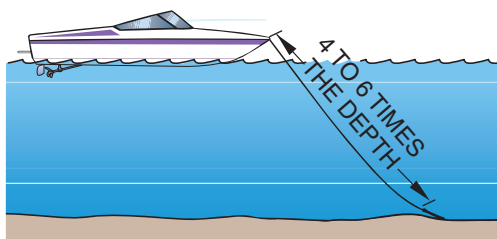

KC-0260C-A

**Figure 8-7**

### Helpful guidelines when anchoring:

- Make sure the anchor line is tied to the anchor. Tie the other end of the line to the forward cleat or bow eye.
- Head the boat into the wind or current over the spot where you want to lower the anchor.
- Stop the boat before lowering the anchor.
- Slowly lower the anchor until it hits bottom.

- Allow the boat to back away keeping tension on the line.
- Release at least seven times as much line as the depth of the water.
- Secure the anchor line to the bow cleat or eye.
- Firmly pull on the line to make sure the anchor is holding.
- Occasionally check your position against the shoreline. If the anchor is dragging and the boat is drifting, reset the anchor.

## **Helpful guidelines when weighing (pulling in) the anchor:**

- Start the engine(s).
- If necessary, move forward until enough tension is off the anchor line to allow for retrieval of the anchor. Avoid running over the anchor line; retrieve the line as you approach the anchor.
- Once the anchor line is straight up and down, lift the anchor from the bottom.
- If the anchor is stuck, attach the anchor line to the bow cleat so that it is tight. The up-and-down motion of the bow from wave action may loosen the anchor from the bottom. If the anchor remains stuck, let out a few more feet of line and attach it to the bow cleat. While keeping tension on the line, slowly maneuver the boat around the anchor to help loosen it. Avoid running over the anchor line.
- Always stow and secure the anchor and line before departing.

## Lines and Knots

Mooring, anchor and other nautical lines are constructed from many different types of materials, and are available in many diameters and styles. Consult with your local marine supply store for a recommendation of appropriate lines for your boat and application. Commonly used mooring lines are constructed of a high-quality synthetic material in a double-braided configuration and usually have eye splices on at least one end.

You should learn and become familiar with tying and using knots. Knowing how to use knots and lines properly can prevent personal injury and property damage.

Practice tying lines to docks, cleats and anchors, and connecting two lines together. Consult other qualified boaters or local marine authorities, or visit your local bookstore, library or the Internet for information on the proper use of nautical lines and knots. The following illustrations represent a few examples of securing mooring lines.

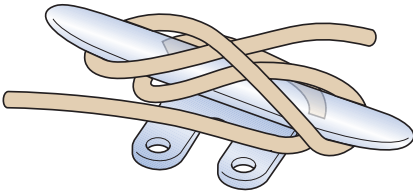

**Cleating an open line**

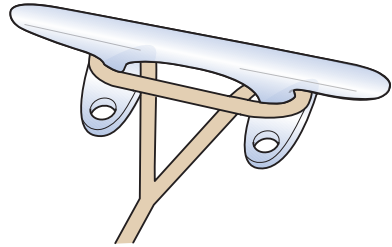

**Cleating an eye spliced line**

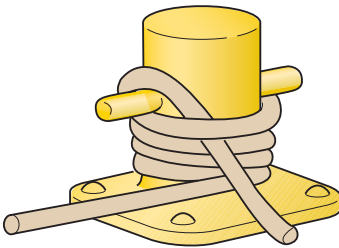

**Securing to a dock bit**

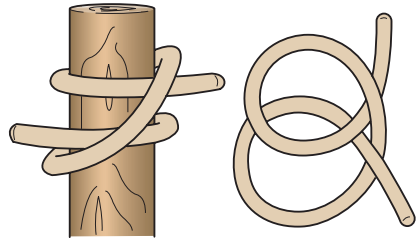

**Securing to a piling using a clove hitch**

KC-0248C-A

**Figure 8-8**

Section 9

# TRAILERING AND LAUNCHING

Before using your trailer, see *Safety on page 3-1*.

## LEGAL CONSIDERATIONS

The following information is intended as a basic guideline only. See the *Trailer Operator's Manual* for information for operation, adjustments and maintenance.

Before you use your trailer, contact your state's Department of Motor Vehicles (and that of other states through which you may be traveling) for information on trailering regulations. Trailer regulations vary widely from state to state, and it is your responsibility to be in compliance with all regulations when trailering your boat.

Regulations include, but are not limited to, trailer registration, licensing, width, height, length, lights, safety chains, tie-downs, hitch type, weight capacity, brakes, spare wheels, vehicle mirrors and gross vehicle weight.

## TRAILER TYPE

Trailers are designed for many applications and can vary in style. To prevent damage to your boat and/or personal injury, always use the appropriate trailer for your boat. Contact your dealer for more information.

## TRAILER CLASSIFICATION

Trailers are separated into four classes based on the Gross Vehicle Weight Rating (GVWR):

Trailer Class	GVWR
Class One	under 2000 lb (907 kg)
Class Two	over 2000 lb (907 kg) and under 3500 lb (1588 kg)
Class Three	over 3500 lb (1588 kg) and under 5000 lb (2268 kg)
Class Four	over 5000 lb (2268 kg)

## TRAILER GROSS VEHICLE WEIGHT RATING

All trailers must display a Gross Vehicle Weight Rating (GVWR) decal, which shows the load-carrying capacity plus the weight of the trailer. The total weight of your boat (fully loaded with fuel, batteries, water, etc.), engine, gear and trailer must never exceed the GVWR.

## VEHICLE TOWING HITCH

The towing vehicle must be able to safely pull the full trailer and boat load. The vehicle must have a towing hitch that is capable of safely handling the trailering load and tongue weight of the trailer.

Hitches are designed for many applications and can vary in style. You should seek professional assistance when selecting the correct hitch and hitch ball for your towing application. **WARNING! A vehicle hitch that is underrated or improperly installed can lead to loss of control of the trailer and/or vehicle, causing serious personal injury or even death.**

Hitches are divided into classes that specify the trailer's gross trailer weight and maximum tongue weight for each class. **WARNING! Never use a hitch that is not rated to pull the maximum weight of your trailering load or that is not rated for the maximum tongue weight that your trailering load applies.**

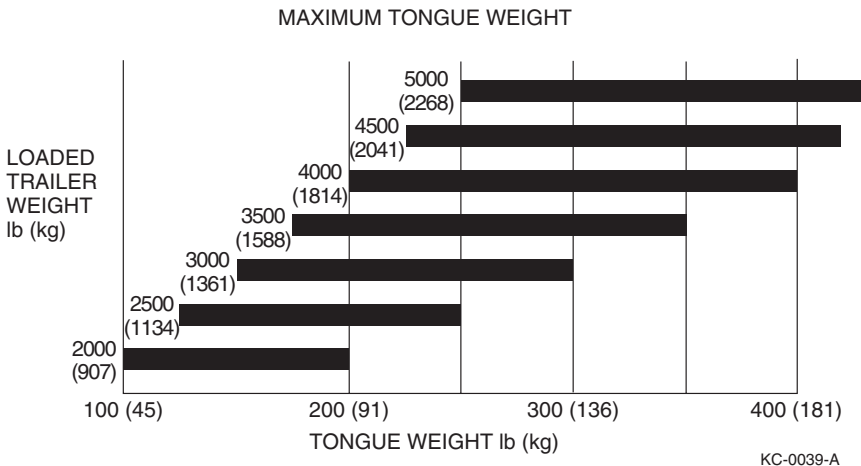

**Figure 9-1**

## HITCH BALL AND TRAILER COUPLER

Most boat trailers have a coupler that connects to a hitch ball attached to the towing vehicle's hitch. The trailer hitch coupler must always match the size of the hitch ball. The correct hitch ball diameter for the coupler is usually marked on the trailer coupler. **WARNING! Never use a hitch ball size or rating that does not match the trailer coupler specifications.**

Trailer hitch balls are sized and rated for use based on the trailer GVWR:

Trailer Class	GVWR	Hitch Ball Diameter Size
Class One	under 2000 lb (907 kg)	1-7/8 in. diameter size
Class Two	over 2000 lb (907 kg) and under 3500 lb (1588 kg)	2 in. diameter size
Class Three	over 3500 lb (1588 kg) and under 5000 lb (2268 kg)	2 in. diameter size
Class Four	over 5000 lb (2268 kg)	2-5/16 in. diameter size

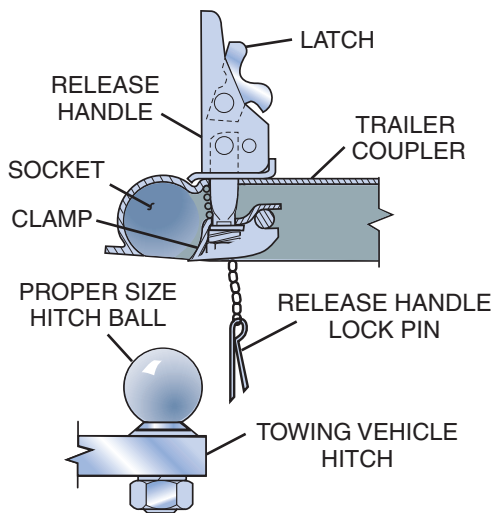

KC-0043C-A

Figure 9-2



### SAFETY CHAINS

Your boat trailer's safety chains prevent the trailer from completely detaching from the towing vehicle when under way. Connect the chains to the vehicle's hitch or frame and crisscross the chains under the trailer tongue to prevent the tongue from dropping to the road if the trailer separates from the hitch ball. Rig the chains as tight as possible with enough slack to permit full-free turning. Safety chains must be rated at the same or greater weight capacity as the trailer's GVWR.

Never allow the chains to drag on the ground when trailering.

Attach the chains properly and securely between the towing vehicle and trailer before trailering.

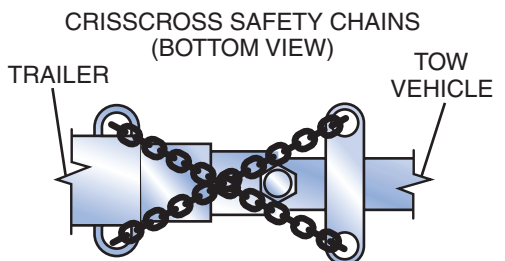

**Figure 9-3**

### TOWING VEHICLE

The towing vehicle must be able to safely pull the full trailer and boat load. Never pull a trailer load that exceeds the vehicle's towing capacity; you risk losing control of the trailer and/or vehicle. Before trailering, always check your *Vehicle Operator's Manual* for maximum towing/trailering load specifications and maximum gross vehicle weight specifications that include the fully loaded trailer.

## TRAILER BRAKES

In some states, any trailer with a GVWR of 1500 lb (680 kg) or more is required to have trailer brakes. Check with your state and local authorities for more information.

The three basic types of trailer brakes are electric, hydraulic surge and air-actuated. If your trailer is equipped with brakes, see the *Trailer Operator's Manual* for more information on operation, adjustments and maintenance.

### Typical

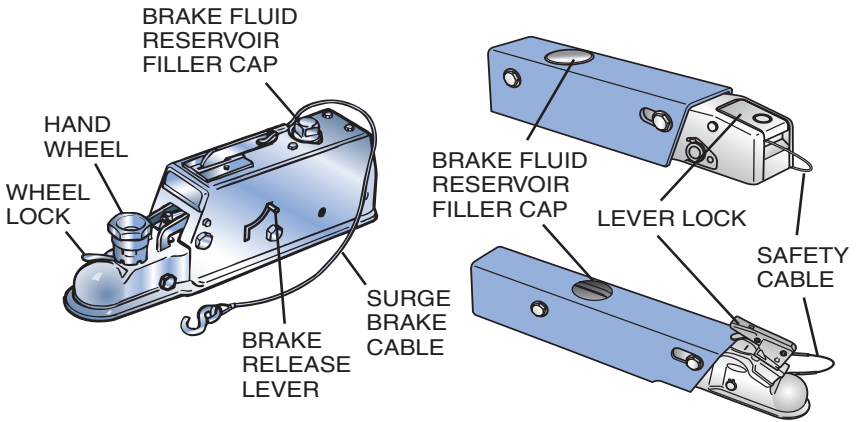

CNTRN-0057-A

**Figure 9-4**

## 5-Pin Wiring Connector

Some trailers equipped with surge brakes may utilize a 5-pin wiring connector. These trailers use an electric solenoid valve that allows brake fluid to bypass back to the reservoir while in reverse. The solenoid is usually connected to the reverse lights on the tow vehicle to ensure the brakes only bypass in reverse. The fifth pin is for deactivating the brakes when backing up, and is required to be connected to the vehicle's power when backing up. In some instances the 5-pin connector can be connected to a 4-pin connector for normal operation of the lights.

# TRAILERING GUIDELINES

Follow these guidelines when trailering:

- Maintain a safe speed as regulated by the trailering laws of the state where you are traveling.
- Check the trailer and vehicle brakes for proper operation and fluid level prior to departure.
- Check the trailer for damage prior to departure.
- Once the trailer is secured to the vehicle hitch, stow the trailer jack or lift (if equipped) so that it will not hit the ground.
- Check the trailer and vehicle tires for proper inflation. Under-inflated tires heat up rapidly and may cause tire damage or failure.
- Check trailer wheel bearings and lug nuts before each trip.
- Fasten the bow of the boat to the trailer with the bow winch line connected to the bow eye and bow safety chains (if equipped).
- If travel conditions require, use an additional tie-down strap across the rear of the boat from side to side to further secure the stern.
- Secure the stern of your boat to the trailer from the stern eyes.
- Check all strapping material for wear.
- Make sure trailer and vehicle running, brake and signal lights are in good working condition.
- Drive with the vehicle and trailer running lights on.
- Too much or too little tongue weight makes steering difficult and causes the tow vehicle to sway. Approximately 5% to 10% of boat and trailer weight should be placed on the tongue.
- Remove any covers or bimini tops (if equipped) that are not designed to stay on boats at highway speeds.
- Carry a spare tire and wheel for both your trailer and your towing vehicle, along with tools to change them.
- See the *Engine Operator's Manual* for engine-related trailering information. Continuous road shocks may fatigue the boat steering system.
- On extended trips, carry spare wheel bearings, seals and races.
- While traveling, check the wheel hubs every time you stop. If the hub feels abnormally hot, inspect the bearing before continuing your trip.
- Carry a fire extinguisher in the vehicle.
- Drive slowly over railroad tracks or rough roads.
- Turn carefully while towing a trailer; additional space and distance are needed.
- If you trailer your boat from lake to lake, you may unknowingly introduce a foreign aquatic species from one lake to the next. Thoroughly clean the boat below the waterline, remove all weeds and algae, and drain the bilge and livewells before launching the boat in a new body of water.
- Make sure the hitch ball and trailer coupler are the same size and bolts and nuts are tightly secured.

- The coupler must be completely over the ball and the latching mechanism locked down.
- Make sure the lights on the trailer function properly.
- The safety chains must be attached crisscrossing under the coupler to the frame of the tow vehicle. If the ball was to break, the trailer would follow in a straight line and prevent the coupler from dragging on the road. Make sure the trailer emergency brake cable or chain is also installed to the tow vehicle frame.
- Make sure the tow vehicle has side view mirrors that are large enough to provide an unobstructed rear view on both sides of the vehicle.

Note: Make sure your towing vehicle and trailer are in compliance with all state and local laws. Contact your state motor vehicle bureau for laws governing the towing of trailers.

## Backing Up

If you have never towed a trailer before, take time to practice and become comfortable with backing up your boat and trailer. Situations can arise in traffic, or when launching, that will require you to be able to back up your trailer safely.

Follow these guidelines when backing a trailer:

- Back slowly and make small steering adjustments.
- Turn the car wheels in the direction opposite where you want the trailer to go.
- After the trailer begins moving, turn the car to follow it.
- Have a second person assist you with audible and hand signals.

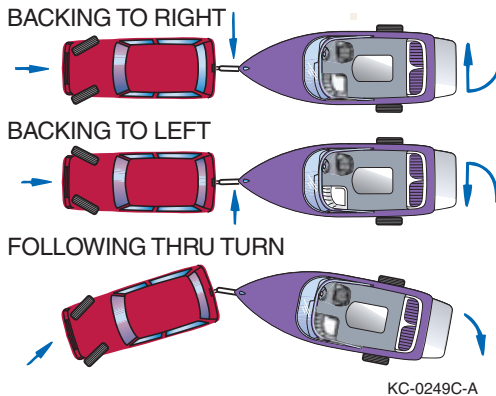

Figure 9-5

### LAUNCHING

Before launching, inspect the launch ramp for any problems that may hinder launching or make launching unsafe. Ramps can be slick and dangerous to drive or walk on, and may have unseen drop-offs beneath the water that would pose a safety hazard. Always be aware of water conditions and the effects of the wind when launching.

Before launching your boat, inspect the boat and trailer for damage. Do not launch if you detect damage or find that the engine or propeller is not in good operating condition. Have any repairs made before launching.

Use courtesy when preparing the boat for launching by doing so away from the ramp on level ground before proceeding to the launch ramp.

When launching your boat on the trailer, have two or more people assist you. Since all launches are different, the following procedures are intended as guidelines only:

- Verify that your vehicle's brakes, including the parking brake, are in proper working order.
- Make sure the trailer is securely fastened to the vehicle.
- Remove the boat cover, if equipped.
- Check that the bilge drain plug is in place and all other plugs that allow water to leak into the boat are in place.
- Remove all tie-downs from the boat.
- Attach the bow and stern docking lines.
- Attach boat fenders if necessary.
- Disconnect the trailer lights from the car if applicable, some trailers using surge brakes require the 5-pin harness connected to the vehicle to allow the trailer to be backed-up.
- Make sure the bow winch and strap are securely locked and fastened.
- Make sure all required documentation and safety equipment are on-board.
- Verify that batteries are fully charged and in good condition.
- Check fuel level; add fuel if necessary.
- Always launch with the help of another person.
- Make sure there is no one on the ramp behind the boat.
- Keep the trailer/vehicle combination as straight as possible and at 90 degrees to the shoreline.
- Back slowly down the ramp until the transom of the boat is a few inches under water; then stop the vehicle.
- Stop the vehicle and shift into PARK (automatic transmission) or REVERSE (manual transmission). Apply the brakes and/or parking brake. If possible, use wheel blocks.
- Position the mooring lines within reach of the dock.

- Disconnect the bow winch strap and safety chains, (if equipped), from the bow eye.
- Manually back the boat clear of and off the trailer into the water and secure to the dock using mooring lines.
- Remove any wheel blocks and release the vehicle brakes. Pull the trailer slowly out of the water, and secure and park in a designated area.
- Board the boat.
- Run the bilge blowers as required, if equipped.
- See the *Engine Operator's Manual* for starting procedures.
- Remove dock lines from the dock and proceed slowly away from the dock.

## LOADING GUIDELINES

Follow these guidelines while loading the boat onto the trailer:

- When loading your boat on the trailer, have two or more people assist you.
- Stop, turn off the boat and secure it to the dock with dock lines at a position clear from where the trailer will be in the water.
- Verify that your vehicle's brakes, including the parking brake, are in proper working order.
- Disconnect the trailer lights from the car if applicable, some trailers using surge brakes require the 5-pin harness connected to the vehicle to allow the trailer to be backed-up.
- Make sure the trailer is securely fastened to the vehicle.
- Back the trailer slowly down the ramp until it is positioned so that the boat can be loaded.
- Stop the vehicle and shift into PARK (automatic transmission) or REVERSE (manual transmission). Apply the brakes and/or parking brake. If possible, use wheel blocks.
- Position the mooring lines within reach of the dock.
- Manually position the boat onto the trailer using mooring lines. Make sure the boat is centered on the supports of the trailer.
- Position the bow eye into the bow stop and connect and secure the bow winch strap and safety chains (if equipped) to the bow eye.
- Secure the mooring lines inside the boat.
- Remove any wheel blocks and release the vehicle brakes. Slowly pull the trailer and boat up the ramp.
- Secure the transom to the trailer.
- Prepare for trailering as necessary.

**This Page Intentionally Left Blank**

*Section 10*

## **BOAT FEATURES AND OPTIONS**

This section includes general and specific information about major systems and components that may be standard, optional or not applicable on your boat. For specific information on the systems and components in your boat, see your local Centurion dealer.

### **STEERING SYSTEM**

A mechanical-type rack and pinion steering system is used to transfer the helm rotary movement to linear motion in the cable which pushes or pulls the rudder arm and rudder to change the direction of the boat.

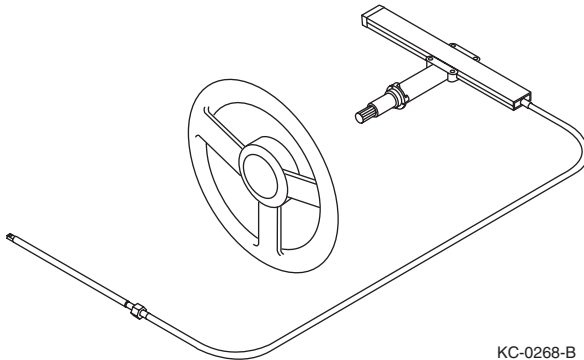

**Figure 10-1**



## Tunable Rudder

Depending on boat application and operation, steering torque adjustments may be necessary to suit specific driving requirements. A tunable rudder is designed to reduce steering effort at the helm. This type of rudder utilizes an adjustable tab or foil that can be moved independently of the main rudder blade to increase or decrease the amount of load that is noticed at the helm.

The following adjustment procedure is typical and may not apply to the specific rudder on your boat. For additional information contact your dealer.

An adjustable tab or foil is located on the main rudder blade. The tab or foil is adjustable in small increments port or starboard by the use of a set screw-type adjustment.

If the boat is pulling to port, move the tab or foil to port and tighten the set screws. If the boat is pulling to starboard, rotate the foil to starboard and tighten the set screws. As a typical rule, the movement of the trailing edge of the tab or foil to one side will cause the helm steering to pull to the opposite side.

When making adjustments, make small adjustments and retest. Only small adjustments (1/8 in. to 1/4 in.) are needed to make a correction. It may take more than one adjustment to get the desired setting. Always tighten the adjustment screws after each adjustment. **WARNING! Failure to tighten the adjustment set screws could cause erratic steering and serious damage or personal injury.**



CNTRN-0020C-A

**Figure 10-2**

# Boat Features and Options

Adjusting tab to port  
will turn boat to port.

Adjusting tab to  
starboard will boat to  
starboard.

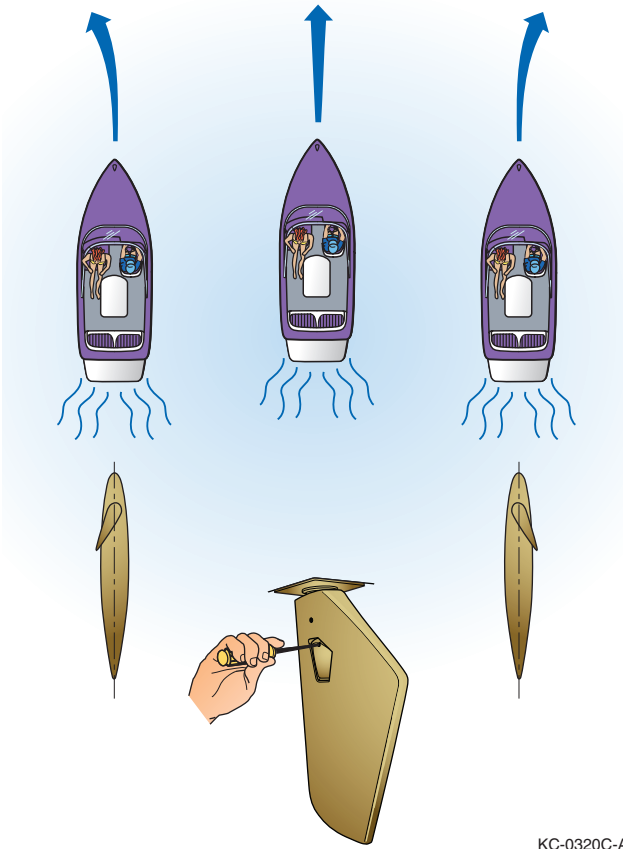

KC-0320C-A

**Figure 10-3**

## SHIFT AND THROTTLE CONTROLS

Knowing how to operate the shift and throttle controls of your boat is essential for safe and proper operation.

The following basic and typical information may not apply to your specific shift control. See the *Engine Operator's Manual* or control manufacturer's instructions for information on your throttle and shift control operation, adjustment and maintenance.

### Single-Lever Controls

Single-lever controls operate both the gear shift and the throttle for one engine with one control lever.

- **NEUTRAL** - The lever is detented in the NEUTRAL position (center of travel) for starting; the neutral safety switch allows starting in this position only. For engine warm-up, a separate lever or button on the control is used to disengage the shift cable and allow the throttle to advance only while the transmission remains in NEUTRAL.
- **FORWARD** - Release the detent lock to allow shifting to the FORWARD position. Moving the lever into the first 15° of travel (toward the bow or up) positions the control in the FORWARD detent IDLE position. Advancing the lever beyond 15° allows throttle increase in FORWARD.
- **REVERSE** - Release the detent lock to allow shifting to the REVERSE position. Moving the lever into the first 15° of travel (toward the stern or down) positions the control in the REVERSE detent idle position. Advancing the lever beyond 15° allows throttle increase in REVERSE.

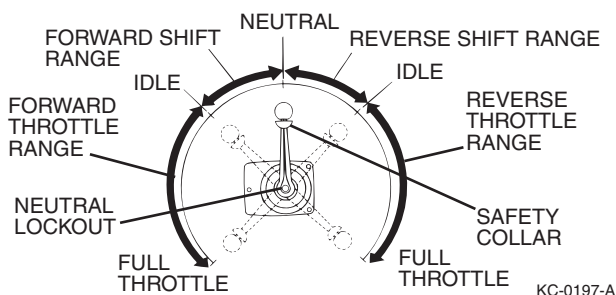

Figure 10-4

## Typical Shift and Throttle Control



CNTRN-0014C-A

*Figure 10-5*

## Control Operation Guidelines

**WARNING!** *Improperly maintained controls are hazardous and may cause sudden loss of control. Make sure all shift/throttle hardware and cables are regularly inspected and maintained. Improper maintenance may result in a loss of control, resulting in serious injury or death.*

- Most throttle and shift controls have a neutral detent locking lever that must be released before shifting from NEUTRAL.
- Always pause in NEUTRAL before shifting from FORWARD to REVERSE, or REVERSE to FORWARD. Most throttle and shift controls have a detent position for NEUTRAL, FORWARD and REVERSE engagement positions. These detent positions are important when shifting and should always be used to pause while shifting into and out of gear. Engine damage may occur if you rapidly shift into gear without pausing or allowing the engine RPM to lower into the approved shifting range.
- When traveling at high speed, never shift into REVERSE while the boat is in FORWARD gear.
- Always keep the shift control clean and clear of obstructions. *NOTICE: All shift and throttle controls are equipped with a safety switch for start-in-gear prevention. Place the control in the NEUTRAL position before you attempt to start the engine.*
- Never attempt to shift when the engine is not running.

### GAUGES / INSTRUMENTS

The following basic information may not apply to your specific boat. This section may not cover all gauges on your boat. See the *Engine Operator's Manual* or equipment manufacturer's supplied information on the use and operation of the unique gauges and instruments. Some models may be equipped with a multi-gauge instrument which integrates the functions of several single gauges.

Gauges are visual indicators that help you monitor various system and component operation parameters. Gauges usually have lights integrated into them for visual clarity when operating at night. They are located near the helm area or other main control areas.

#### Typical Helm



CNTRN-0028C-A

**Figure 10-6**

#### Speed Control System Gauge

Your boat may be equipped with an optional speed control system. (Control systems and indicators may vary.) The speed control system can be used to set constant boat speeds for wakeboarding, water-skiing or wake surfing. The system may operate in either a speed or RPM mode to control the speed at the setting you prefer. See the *Speed Control Operator's Manual* in your *Owner's Information Kit* for proper setup and operation before use.

## Speedometer / Voltage / Fuel Level (Multi-Gauge)

The speedometer indicates the water speed of the boat in miles per hour (mph). There is a calibration knob located on the dash to adjust the speed to match a GPS or a timed and measured distance on the water.



CNTRN-0018C-A

**Figure 10-7**

The voltage gauge indicates the voltage of the electrical system in your boat. It is normal for the voltage to drop during the cranking of your engine. The voltage gauge normal operating range is 12 to 14.5 volts.

The fuel level gauge indicates the approximate level of fuel in your tank. Each system should be checked for fuel usage and overall gauge accuracy. For example, fill your tank completely and run to exactly the half-full level according to the gauge. Refill your tank until full. This will give you the amount of gallons in the top half of the gauge. Repeat this procedure for the 1/4 and 3/4 locations on your gauge for fuel level use. DO NOT attempt to run your fuel gauge down to empty. It is recommended that you not allow your tank to get below 1/4 level to help prevent condensation of moisture in your tank and to also help to prevent running your electric fuel pump dry.

### Speedometer Paddle Wheel

The speedometer uses a thru-hull mounted paddle wheel speedometer pickup. The speedometer receives an electrical signal generated by the rotating paddle wheel pickup to display the forward speed of the boat. The paddle wheel must be able to rotate freely and must be free of all debris in order to provide an accurate signal to the speedometer.

*NOTICE: When trailering the boat, remove the paddle wheel pickup to avoid damage to the pickup assembly. During normal operation the paddle wheel is cooled by water. During trailering, air moving past the paddle wheel will cause the wheel to spin freely and possibly overheat, causing damage to the pickup assembly.*

Remove the boat from the water before removing the paddle wheel. Locate the paddle wheel sensor in the bilge area and remove the sensor cover. Disconnect the paddle wheel from the pickup assembly and remove it. Replace the sensor cover and store the wheel in a safe place.

#### Typical Paddle Wheel



CNTRN-0008C-A

**Figure 10-8**

## Typical - V-Drive Paddle Wheel Sensor Location

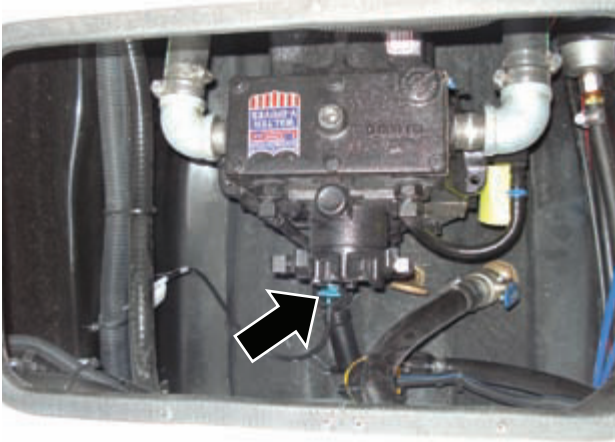

CNTRN-0038C-A

*Figure 10-9*

## Typical - Direct Drive Paddle Wheel Sensor Location



CNTRN-0039C-A

*Figure 10-10*



### Tachometer / Engine Temperature / Oil Pressure / Hour Meter (Multi-Gauge)

The tachometer indicates the revolutions per minute (RPM), of the crankshaft of your engine. This output can be used as an alternative to a speedometer depending on weight loading and water conditions. It is recommended that you not exceed the manufacturer's suggested RPM during break-in and normal operation of your engine. Exceeding the manufacturer's suggested RPM may cause damage to your engine. See the *Engine Operator's Manual* for more information.

The temperature gauge indicates the engine coolant temperature while the engine is running. Normal operating temperature range is between 170° F and 194° F. It is recommended that you not drive your boat at or near wide open throttle until the engine temperature has risen to the normal operating range.

The oil pressure gauge indicates the engine oil pressure while the engine is running. The oil pressure is measured in pounds per square inch (psi). This pressure will vary depending on the RPM of the engine.

The hourmeter is an electronic clock, which records the length of time the ignition switch is on with the engine running. This will be used to gauge the time for maintenance for all components of your boat. It is recommended to keep a logbook recording the hours and time of any maintenance or service work performed on your boat.



CNTRN-0019C-A

Figure 10-11

## Water Depth / Temperature & Air Temperature Gauge

The optional depth sounder will meter and display water depth, air and surface water temperatures. It also offers an audible alarm and an LCD display. See the *Depth Sounder Operator's Manual* for more information.

### Typical



CNTRN-0001C-A

**Figure 10-12**

## V-Drive Warning Indicator

The V-drive warning light indicates the V-drive is overheating. It is normal for the V-drive warning light to stay on after starting the engine until the engine speed increases to 1200 RPM. See the *V-Drive Operator's Manual* for additional information. **NOTICE: DO NOT RUN the V-Drive if the warning light is on when the engine is above 1200 RPM.**



**Figure 10-13**

## Trim Tab Indicator

The optional trim tab indicator (indicators may vary) shows the percentage of deflection of the trim tab in the water. For additional information on the trim tab system, see *Trim Tab (Optional)* on page 10-26 and the *Trim Tab Operator's manual*.

### Typical



CNTRN-0037C-A

**Figure 10-14**

## Switch Blade System Control Indicator

The optional Centurion Switch Blade system control (control indicators may vary) indicates the position of the blade when the system is ON. For additional information on the Switch Blade system, see *Switch Blade (Optional)* on page 10-28 and the *Switch Blade Operator's Manual*.

## HELM AND CONTROL SWITCHES

The number and type of switches and breakers at the helm vary by model, as do the identification tags and the ratings of the breakers. The following is a general reference, as some models may not include all of these switches or others not described here.

### Typical Helm



CNTRN-0027C-A

*Figure 10-15*

### Typical Switch Panel



*Figure 10-16*

### Engine Emergency Stop Switch and Lanyard

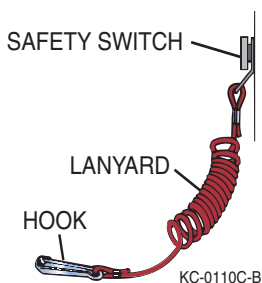

The engine emergency stop switch controls the engine ignition ON/OFF. This safety device shuts the engine off immediately and prevents the boat from becoming a runaway if the operator is accidentally thrown from the seat or away from the helm.

Whenever the boat's engine is on, one end of the emergency engine stop switch lanyard should be physically secured to the emergency stop switch and the other to the boat operator. If the operator is thrown from the seat or moves too far from the helm, the lanyard will disconnect from the switch, activating the switch to turn off the engine.

- Never remove or modify the engine emergency stop switch and/or lanyard.
- Always keep the lanyard free from obstructions that could interfere with its operation.
- Always check the switch for proper operation. With the engine running, pull the lanyard. If the engine does not stop, have the switch repaired before operating the boat further.
- Never operate the boat if the engine emergency stop switch does not work.  
**WARNING! Removing the engine stop switch and/or the lanyard can cause loss of control. See the safety precautions in the Safety Section of this manual for more details.**

### Ignition Switch

The ignition switch is a four-position switch: Acc/Off/Run/Crank. Do not try to force the key into the ignition switch. The key tumblers are located vertically.

### Neutral Start Safety Switch (Start in Gear Prevention)

The neutral start safety switch provides start-in-gear prevention. The switch controls power to the engine starter circuit of the ignition switch. The engine gear shift control lever must be in the NEUTRAL position to allow the ignition switch to activate the engine starter. This safety device will prevent the boat's engine from starting if the engine is in gear.

## Navigation Lights Switch

The navigation lights switch is a three-position switch. The ANCHOR position is used when your boat is at rest after dark in open waterways. In this position only will the 360° tower light or pole light will be illuminated. When your boat is under way between sunset and sunrise, the switch must be placed in the NAVIGATION position. This will activate both the 360° tower and/or pole light, but also the bow red/green running lights. *NOTICE: Boats not equipped with towers are not equipped with international lighting for use in coastal waters.*

Never operate the boat between sunset and sunrise using only the stern light. Use all navigational lights when operating under way between sunset and sunrise. For additional information, see *Navigational Lights & Night Operation* on page 7-2.

## Blower Switch

The blower switch is used to activate the engine compartment blower. When in the ON position the blower will help to eliminate any fumes from the engine compartment. **WARNING! Gasoline vapors can explode. Before starting the engine, operate the blower for four minutes and check the engine compartment for gasoline leaks and vapors. Always run the blower below cruising speed.**

## Bilge Pump Switch

The bilge pump switch is used to activate the bilge pump. When in the ON position the bilge pump is activated to pump out any excess water in the bilge area. The bilge pump also has a float switch that automatically turns on when the water level rises approximately 1.5 in. or more in the bilge area.

## Horn Switch

The horn switch controls power ON/OFF to sound the horn.

## Courtesy and Docking Light Switch

The courtesy light switch is a three-position switch that operates lights located in the cockpit and bow, under the observer seat, and on V-drive models in the rear hatch compartments. The switch also operates the optional docking lights if installed on your boat. Use docking lights for slow speed docking and loading of your boat. Do not use them while operating your boat above idle speeds.

## Tower Light Switch (Optional)

The tower light switch controls power ON/OFF to the lights mounted on the ski tower. The tower light switch is a three position switch: UP (forward lights), DOWN (rear lights) and CENTER (OFF).

### Trim Tab Switch (Optional)

The trim tab switch controls power ON/OFF to the trim tab electric hydraulic pump. This switch is usually a three-position lever switch, with OFF in the center. For additional information on the trim tab system, see *Trim Tab (Optional)* on page 10-26 and the *Trim Tab Operator's* manual.



CNTRN-0025C-A

Figure 10-17

### Ballast Tank Pump Switch (Optional)

The ballast tank pump switch is a three-position switch. When in the IN position, the selected ballast tank will fill. When in the OUT position, the selected ballast tank will empty. **NOTICE:** For longer pump life, do not run ballast tank pumps dry. For additional information on the ballast tank system, see *Ballast Tank System (Optional)* on page 10-21.

### Cockpit Heater Switch (Optional)

The heater switch turns on the optional cockpit area heater blower. For additional information on the cockpit heater system, see *Cockpit Heater System (Optional)* on page 10-29 and the *Heater System Operator's* manual.

## Stereo (Optional)

The optional stereo system is located in the helm panel area or in the glove box. (Stereo systems may vary.) Some models may include an optional stereo remote control allowing control of the stereo from either the helm area or from the transom of your boat. See the *Stereo Operator's Manual* in your *Owner's Information Kit* for instructions on the proper operation of the stereo before use.

### Typical Stereo



*Figure 10-18*

### Typical Stereo Remote Control



CNTRN-0029C-A

*Figure 10-19*



### FUEL SYSTEM

Basic fuel systems consist of one or more fuel tanks, tank vents, a level sensor and gauge, lines, pumps and valves.

Each tank has an antisiphon valve to prevent fuel from leaking out of the tank should a break occur in the system at a point other than the tank. If equipped with multiple tanks, the system also includes a fuel tank selection valve for individual tank selection and a fuel manifold. The manifold is usually located in the engine compartment and contains a series of fuel feed valves for controlling fuel flow/shutoff to the engines. Refer to your boat and *Engine Operator's Manual* for specific fuel system information and service information.

### ENGINE COOLING SYSTEM

Marine inboard engines may be cooled in different ways. Depending on your engine application, an open or self-contained cooling system may be used.

An open cooling system uses raw water (seawater) to cool the engine and/or drive system. A continuous flow of raw water is used to transfer heat from the engine and drive cooling passages and is then returned to the sea. A seacock and raw water pickup on the hull allow water into the engine, and a pump then circulates the water to cool the engine.

A self-contained/closed cooling system uses raw water to cool the engine and/or drive system through the use of a heat exchanger. A continuous flow of raw water is used to transfer heat from the heat exchanger to cool the engine and drive coolant. The engine cooling passages and heat exchanger passages are self-contained/closed, similar to an automotive cooling system. Heat is transferred from the engine and drive to the coolant and circulated through the heat exchanger in the closed system. A separate raw water passage in the heat exchanger is used to transfer heat from the self-contained engine coolant to the raw water. The raw water is then returned to the sea.

Raw water intakes on the hull use a seacock to provide manual shutoff should a leak occur. Periodically inspect the raw water intake screen (if equipped) and clear it of debris that could obstruct water flow into the engine. **NOTICE:** *Keep seacocks closed during periods of inactivity. A downstream hose failure could flood the boat if the seacock is left open. Open seacocks only when necessary.*

## ENGINE EXHAUST SYSTEM

The engine exhaust system vents engine exhaust gases away from the boat. Inboard engines may use mufflers and/or seawater to cool part of the exhaust system. Do not make changes or modifications to the exhaust system. See the *Engine Operator's Manual* for engine exhaust system and service information.

## ENGINE LUBRICATION SYSTEM

Inboard engines, like automotive engines, use a sump system where the engine oil is contained in the engine. See the *Engine Operator's Manual* for engine oil recommendations and service information.

## ELECTRICAL SYSTEM

### DC System

Most boats use a 12-volt common negative ground DC system. DC systems are usually the primary electric supply for lights, pumps, blowers, engine starting, etc.

One battery is required at minimum for engine starting and accessory power. Multiple-battery systems consist of a primary engine starting battery and additional batteries that supply additional power to DC electrical accessory circuits.

Battery switches control battery power distribution and disconnect the batteries from the boat's electrical system. The engine's charging system charges batteries connected to the charging system when the engines are running.

Battery isolators prevent accessory loads and other batteries from depleting power from charged batteries. Isolators also allow the engine's charging system to isolate the alternator charging output and distribute the charge among all batteries according to individual need.

Where applicable, a main DC control panel may feature a voltmeter, battery test switch, fuses, circuit breakers and a master breaker switch. **WARNING! Never reset a breaker that has been automatically tripped without first identifying and correcting the cause of the problem. A fire could result. See Safety Precautions at the beginning of this section for more details.**

## Battery Switch

Battery switches are used to control battery power distribution and disconnect the batteries from the boat's electrical system. Battery switches are designed in many styles and for different applications. They generally provide battery isolation when used with multiple batteries and are used primarily as a method of quick and positive battery disconnection. Battery switches also protect against tampering, electrical fire hazards and battery drain. Keep this switch off when not using your boat or when storing it for extended periods of time. **NOTICE: DO NOT move the battery switch with the engine running; this could damage the engine's charging system.**

Consult a qualified, knowledgeable technician for proper operation of your boat's specific electrical system.

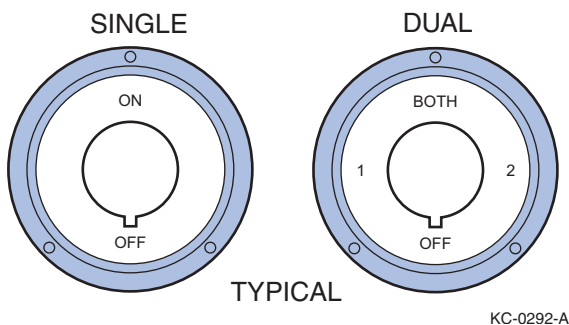

**Figure 10-20**

## BILGE PUMP SYSTEM

The Federal Water Pollution Control Act prohibits the discharge of oil or oily waste into the water. Violators can be fined \$5,000.

Water will enter the boat for a number of reasons, including heavy seas, long periods of rain, leaking seacocks or fittings. The bilge area is usually the deepest part of the hull where the water settles. The bilge pump moves water from the bilge area through hoses and empties it through an opening in the hull.

An automatic bilge pump system features automatic activation of the bilge pump by use of a float switch in the bilge area, that when activated, turns the pump on to allow water to be pumped out. The bilge pump can also be operated manually by a switch at the helm. **NOTICE: DO NOT allow the bilge pump to operate after all the water has been cleared from the bilge area; damage to the pump will occur if you operate it without water. Periodically check the bilge area and float switch and remove any debris that may clog the pump or render the float switch inoperative.**

## BALLAST TANK SYSTEM (OPTIONAL)

The purpose of ballast tanks is to add weight to the boat in designated areas to help produce larger wakes for water sport activities, such as wakeboarding and wake surfing.

The ballast system consists of water tanks, pumps, seacocks, hardware and controls. Panel-mounted switches activate water pumps that fill and drain the tanks with seawater. Seacocks are used to open and close seawater drains.

**DANGER! Never add additional ballast. Additional ballast can make a boat unsafe and illegal to operate.**

**WARNING! When the ballast tanks are filled, reduce the total weight in the boat. By adding ballast, the boat becomes heavier and fewer passengers and/or gear are allowed in order to keep the boat within legal and safe weight limits. The average passenger weighs 141 lb (64 kg). Water weighs approximately 8.4 lb per gallon (1 kg per liter). Fuel/gasoline weighs approximately 6.3 lb per gallon (0.75 kg per liter).**

To fill the ballast tank(s), the engine must be running and in NEUTRAL. Close the drain seacock and then turn the designated tank(s) switch to the ON position to fill the desired ballast tank.

If the tank fills beyond its capacity, the excess water will drain from the tank vent. The pump will continue to operate until the switch is returned to the OFF position.

*(Boat shown with optional ballast tanks for reference only.)*

### Typical Ballast Tank Locations

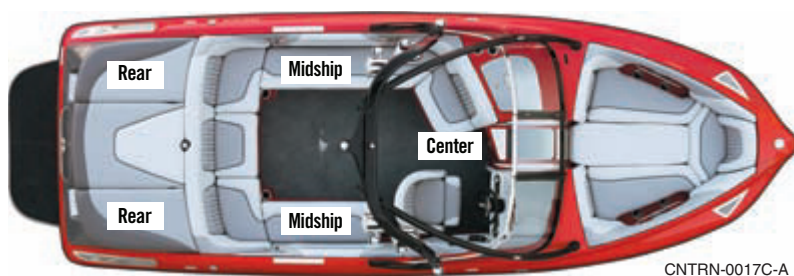

Figure 10-21

## PROPELLER SHAFT DRIPLESS PACKING

The propeller shaft protrudes through the bottom of the hull and is sealed by a dripless-type packing seal mounted to the stuffing box.

Unlike older packing seals, where the propeller shaft was sealed by the use of flax-type packing wrapped around the shaft in the stuffing box or packing gland, a dripless packing seal may use a rubber bellows or sleeve, seals and/or O-rings to seal the shaft.

Typical dripless packing seals use seawater to assist in sealing and cooling the packing seal. **NOTICE:** *If the cooling hose is removed, water will enter the boat while the engine is running.*



CNTRN-0033C-A

**Figure 10-22**

## PROPELLER STRUT

The propeller shaft is supported on the outside of the hull by a strut. The strut integrates a composite bearing supporting and allows the propeller shaft to rotate in the strut.

*NOTICE: The propeller shaft strut bearing is lubricated by water. DO NOT shift the transmission and run the propeller out of the water even if water is supplied to the engine's cooling system. Damage to the shaft and bearing can occur.*

### Typical Propeller and Strut



CNTRN-0021C-A

**Figure 10-23**

## PROPELLER

The propeller converts the engine's power into the thrust needed to propel the boat. Care and selection of your propeller is very important for proper boat operation. Propeller size is usually identified by three numbers, such as 13 x 16 x 1-1/8, and a material identification, such as brass, aluminum or stainless steel. In the number sequence, the first number is the diameter of the propeller in inches and the second is the pitch in inches and the third number is the diameter of the propeller shaft.

Pitch is the angle of the blades expressed in the theoretical distance a propeller travels in each revolution. In the above example, the pitch is 16, which means that each revolution of the propeller pushes the boat 16 inches (406 mm) through the water.

It is recommended that the boat be removed from the water for propeller replacement, as the propeller is not easily accessible while the boat is in the water. A special puller and tools are required to remove the propeller in most applications.

Always consult your local marina or certified marine technician for assistance when replacing or servicing propellers.

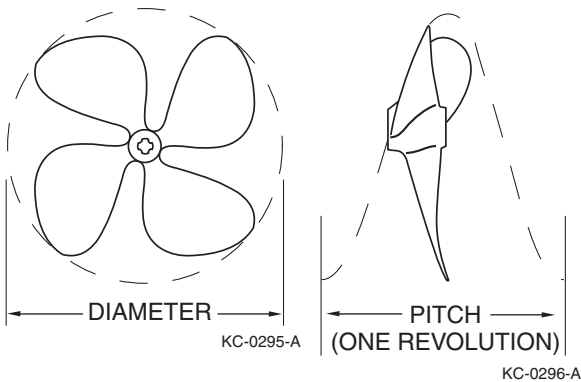

**Figure 10-24**

## Propeller Selection and Replacement Guidelines

There are many different propeller designs for specific operating characteristics.

It is highly recommended that you arrange for your dealer to perform any propeller service, removal or installation procedures.

To prevent personal injury and/or equipment damage, follow these guidelines before installing or removing the propeller:

- Remove the boat from the water into a position where the propeller is accessible.
- Position the shift control in NEUTRAL.
- Position the battery switch to the OFF position or remove the negative battery cable from the engine starting battery to ensure the engine cannot accidentally start.
- Place a wood block between the boat hull and the propeller to hold the propeller in place while removing the propeller nut. **WARNING! Never use your hand to hold the propeller when removing the propeller nut.**
- When removing the propeller, use a propeller puller to remove the propeller following the puller manufacturer's instructions.
- When installing the propeller, verify that the propeller is tight on the shaft and the propeller nut is torqued to the correct specification.

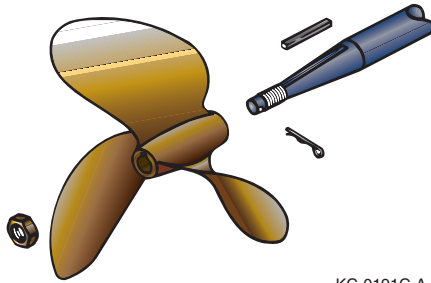

KC-0191C-A

**Figure 10-25**



# ENGINE COMPARTMENT VENTILATION SYSTEM

Ventilation or blower systems are designed to remove explosive vapors that accumulate in the bilge area and engine compartment. Proper ventilation is extremely important to personal safety while boating.

Powered ventilation systems consist of one or more sealed fans that replace vapors with fresh air through intake and exhaust vents. Always operate the blower for at least four minutes before you start the engine. You should also operate the blower continuously when at idle and during slow-speed operation.

Natural ventilation systems also have intake and exhaust vents; as the boat moves, air is forced into the intake vent and escapes through the exhaust vents.

The engine compartment cover is a structural part of the boat and acts as a machinery guard. The engine cover must be in place and closed whenever the engine is running. DO NOT operate your boat with the cover open or with the engine exposed. **WARNING! Contact with moving parts can entangle, cut and can cause death or serious injury. Never make contact with any running machinery moving parts, such as the engine or propeller.**

## TRIM TAB (OPTIONAL)

Trim tabs are either power or manually controlled. (Equipment will vary by model and options.) A powered trim tab is controlled from the helm by a switch and use of a position indicator. A cavitation plate is controlled by manually adjusting the plate adjustment rods to a predetermined position.

A trim tab enhances the planing ability of the boat. When used on inboard ski boats a single trim tab is used to enhance and control the type of wake desired by controlling the hull running attitude.

By controlling the wake characteristics, wakes can be made to enhance water sports such as wakeboarding, barefooting, kneeboarding and towables.

A single tab is usually mounted in the center rear of the hull. Tab movement is controlled from a helm-mounted switch, which activates an electric or electric/hydraulic actuator attached to the tab.

When operating at wakeboarding speeds, with the trim tab in the UP position, the bow rises and the hull rides normally, creating heavy water displacement and large wakes.

When operating at skiing speeds, with the trim tab in the DOWN position, the bow lowers and helps the boat to plane quickly for skiing and slalom skiing-type wakes and allows for pulling more and/or heavier skiers.

See the *Trim Tab Operator's Manual* for additional information.

## Typical Power Trim Tab



CNTRN-0023C-A

*Figure 10-26*

## Typical Cavitation Plate

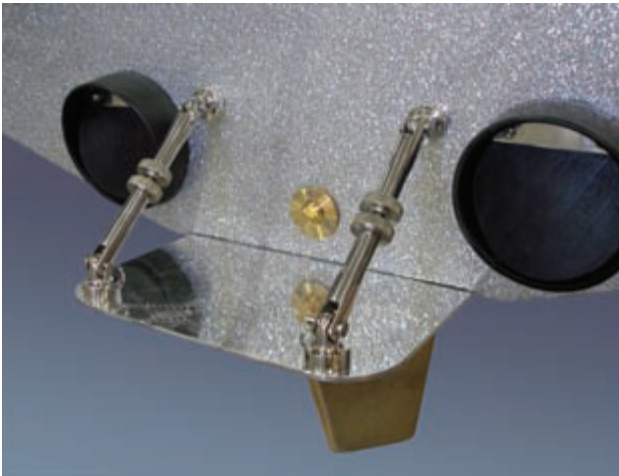

CNTRN-0034C-A

*Figure 10-27*

### SWITCH BLADE (OPTIONAL)

Switch Blade is an optional wake enhancement system designed to help create large wakes through the use of a multi-directional, fully controllable rudder-style wake blade. By controlling stern depth and boat wake characteristics, wakes can be tailored to enhance water sports such as wakeboarding.

Switch Blade is controlled by a control unit at the helm and can be programmed to run in AUTO mode or in MANUAL mode. See the *Switch Blade Operator's Manual* for operation procedures.

#### Typical Switch Blade System

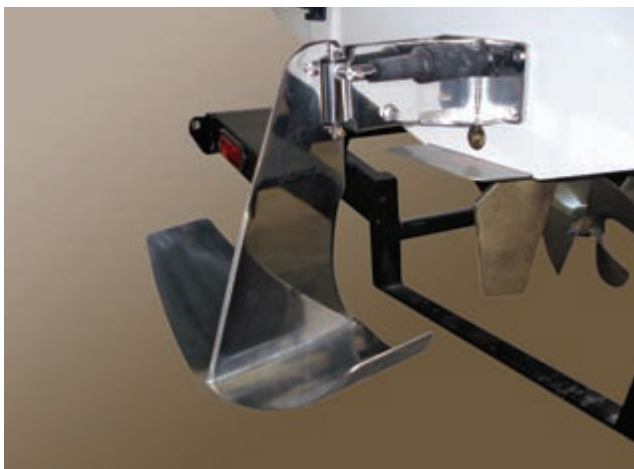

CNTRN-0030C-A

Figure 10-28

### WAKE TOWER (OPTIONAL)

Wake towers are used to provide a higher towing point for water sports and to mount lights and other accessory equipment. Towers are solidly constructed from stainless steel or aluminum and are mounted solid to the boat. Some towers may have an optional folding feature, which allows the tower to be folded for storage or clearance. **WARNING! Misuse or overloading of the wake tower can cause death or serious injury. The wake tower is designed for water sports only. DO NOT use for towing other watercraft, parasailing, kite flying or towing tubes or other similar towables. Read the safety decal on the wake tower before using and DO NOT overload the tower's weight rating.**

## SKI TOW PYLON

The ski tow pylon is designed for towing a wakeboard, skier or other water-towable device. The ski tow pylon is weight-rated. The weight the boat is towing should never exceed the recommend rating. See the safety decal on the ski tow pylon or see the ski tow pylon owner's information that was supplied with your boat.

**WARNING! *Misuse of the ski tow pylon can cause death or serious injury. The ski tow pylon was designed for water sports only. DO NOT use for parasailing, kiteflying or towing other watercraft.***

**WARNING! *DO NOT allow passengers to sit behind the ski tow pylon when it is in use. Always check that the ski tow pylon is secure before each use.***

**WARNING! *The use of a ski tow pylon extension, or any other device attached to the pylon, is not recommended. The use of a pylon extension will alter the load-handling characteristics of the pylon, possibly resulting in a dangerous situation that could cause loss of control, death or serious injury.***

## COCKPIT HEATER SYSTEM (OPTIONAL)

A marine heater uses the heated engine coolant to produce forced air heat through a ducted location in the boat or through a snorkel-type tube. Heated engine coolant is circulated through a heater core and an electric blower fan moves air over the heater core, transferring heat from the heater core to the ducted area air in the boat or on the windshield. Where applicable, the snorkel tube can be moved anywhere within its reach to provide an isolated heat duct. A helm or remote panel-mounted ON/OFF switch operates the heater blower fan.

See the *Marine Heater Operator's Manual* for further information.

**This Page Intentionally Left Blank**



## Section 11

# GENERAL CARE AND MAINTENANCE

Your boat may feature a variety of specialized systems and components. The following basic and typical information may not apply to your specific application. This section may not cover all systems or components on your boat. See the *Engine Operator's Manual* or the equipment manufacturer's information for maintenance procedures.

Maintenance procedures may require special knowledge and equipment. Always consult your local marine dealer or certified marine technician for assistance in performing service, maintenance or modifications to your boat.

Neglect of maintenance and unauthorized service work is not recommended and may void your warranty. Refer to the *Engine and Equipment Manufacturer's* maintenance schedules and requirements, and keep a detailed log of the procedures and dates completed. Always consult your local marine dealer for assistance with periodic maintenance.

## 20-HOUR INSPECTION

A boat inspection is required between the first 15 to 20 hours of boat operation. The following maintenance must be performed at or before the 20-hour inspection by an authorized Centurion dealer. See the *Engine Operator's Manual*, *V-Drive Operator's Manual* or specific equipment operator's manuals for additional information.

- Check propshaft alignment.
- Tighten all engine mounting bolts.
- Tighten all steering, throttle and shift system fasteners.
- Perform all recommended engine maintenance procedures.
- Inspect fuel system for any damage or leaks.
- Inspect ski pylon for damage and proper attachment.
- Check bilge pump for proper operation in manual and automatic modes.
- Inspect all fasteners for tightness.
- Check engine and V-drive fluid levels.

## PERIODIC MAINTENANCE

It is recommended that you read and understand the periodic maintenance procedures outlined in your *Engine Operator's Manual* and *V-Drive Operator's Manual*.

Perform the following inspections semiannually or every 100 hours.

- Perform all related periodic maintenance procedures outlined in your *Engine Operator's Manual* and *V-Drive Operator's Manual*.
- Inspect all hardware for pitting, corrosion or wear, and repair or replace as necessary.
- Clean the battery terminals and inspect the batteries and hold-downs for damage. Repair or replace as necessary.
- Check the propeller shaft coupling alignment. Contact your dealer for service recommendations.
- Check the propeller shaft seal for leakage. Repair or replace as necessary.
- Inspect and lubricate the steering system.
- Lubricate the throttle and shift cables.
- Inspect the exhaust exit flaps (if equipped) for damage. Repair or replace as necessary.

## ENGINE

The manufacturer of your boat's engine(s) will provide a separate maintenance procedure. See the *Engine Operator's Manual* for specific information on maintenance procedures.

## FUEL SYSTEM

A fuel tank vent is located in the filler deck plate. Periodically check that the fuel fill and vent lines are free of obstructions and kinks.

Check and/or replace the fuel filter periodically or clean as needed. Check fuel lines, vent hoses and drain hoses frequently for leaks. Replace any worn or cracked hoses.

Tightening a fitting or clamp may correct a fuel leak. If the leak continues, however, replace the line, fitting or hose immediately to prevent a build-up of fluids or gases.

Use fuel system parts certified for marine use only. Never use automotive parts in marine applications.

## V-DRIVE

The manufacturer of your boat's drive system will provide a separate maintenance procedure. See the *V-Drive System Operator's Manual* for specific information on maintenance procedures.

## STEERING SYSTEM

The steering system is the primary link for boat control and must be inspected and maintained regularly. The following basic inspection and maintenance procedures may not apply to your steering system. For additional information contact your dealer. **WARNING! LOSS OF CONTROL AND UNSAFE BOAT HAZARD. Improper maintenance of the steering system is hazardous and can cause death or serious injury from sudden loss of control. Ensure that all steering hardware, cables and grease fittings are regularly inspected and maintained. If any steering problems are noticed, DO NOT operate the boat and contact your dealer immediately for service assistance.**

- The rack-and-pinion helm gear box is typically a sealed and lubricated unit, which requires no additional lubrication. Contact your dealer for specific information on your helm unit.
- The steering cable requires periodic maintenance and lubrication. Contact your dealer for specific service information.

The rudder arm is connected to the rudder shaft. The rudder shaft is lubricated by the rudder stuffing box. The rudder stuffing box may be sealed or incorporate a grease fitting to allow lubrication during maintenance. Contact your dealer for specific service information.

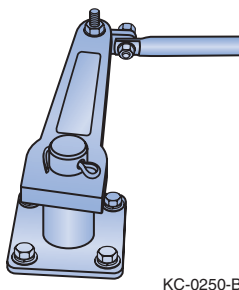

**Figure 11-1**

The rudder should be checked frequently for damage and tightness. If the rudder is damaged or requires service, contact your dealer for service.



## PROPELLER SHAFT DRIPLESS PACKING

The propeller shaft dripless packing requires periodic lubrication and should be lubricated at least once before the start of the season. Contact your dealer for specific service information.



CNTRN-0061C-A

**Figure 11-2**

## ELECTRICAL SYSTEM

Before performing any work on the electrical system or battery, see *Safety on page 3-1*.

### Battery

Always turn off the battery switch (if equipped) or disconnect the negative battery cable before servicing the electrical system.

When you install a battery:

- Always use correct polarity when you connect the battery cables to the battery.
- Make sure the battery terminals are clean.
- Make sure the cable connections are tight.
- Always shut down the engine before removing or attaching battery cables. Never run the engine with the battery cables disconnected.
- Always remove the negative (-) cable first. Always attach the negative (-) cable last.

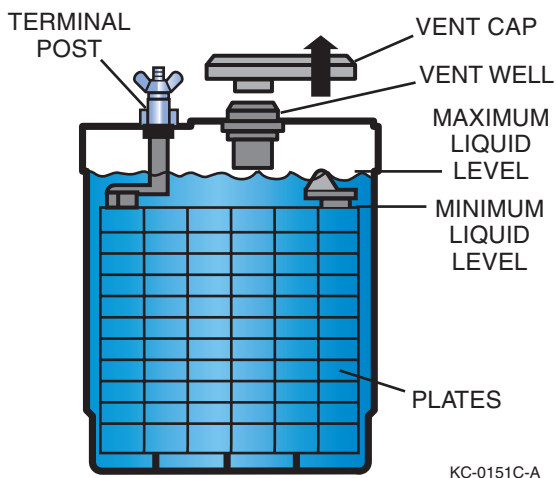

**Figure 11-3**

Check the battery frequently for signs of corrosion. If corrosion is evident, clean the terminal posts with a baking soda and water solution and a wire brush. Disconnect the battery terminals before cleaning.

Check the fluid levels in the cells. **NOTICE:** *Some batteries are sealed and cannot be filled.* A level of approximately 1/4 to 1/2 in. (6 to 13 mm) above the plates is sufficient. If needed, fill with distilled water; do not overfill! **WARNING! Lead acid battery fluid can cause severe burns.**

During extended periods of non-use batteries will self-discharge and should be recharged. Before recharging, disconnect the battery terminals and remove the battery from the boat. Recharge the battery according to the directions enclosed with your battery and battery charger. When installing the battery in the boat, make sure the battery is secured in the battery box, the terminals are tight and all protective covers are in place. **WARNING! Hydrogen gases produced by a lead acid battery while it is charging, or the engine is running, can cause an explosion and/or a fire.**

### Circuit Breakers and Fuses

Never exceed the recommended fuse sizes or bypass a fuse in a circuit. Always install the proper (type and rating) fuses whenever replacing or changing fuses. Continuous fuse/breaker failures indicate a severe problem and require immediate attention. **WARNING! Installing an incorrect fuse or breaker can cause a fire.**

Some applications use circuit breaker switches to provide individual circuit protection with the ability to manually reset the breaker switch.

To reset a tripped circuit breaker, position the breaker switch to OFF. Identify and correct any problems with the circuit and unplug all loads connected to it. Wait a minimum of one minute for the breaker switch to cool and then push the breaker switch to ON. Turn the breaker switch to OFF immediately if it trips, and consult qualified personnel.

To replace a fuse, locate the fuse block and the failed fuse. Carefully remove the fuse without touching other fuses or wires. When possible, use a fuse removal/installation tool. **WARNING! Never reset a breaker that has been automatically tripped, or replace a burned out fuse, without first identifying and correcting the cause of the problem. A fire could result. NOTICE: A boat's electrical system is designed to protect you from electrocution, short circuits and overloads. Have a qualified electrician perform any modifications to the system, such as adding electrical accessories. Some installed accessories, such as stereos, have an additional fuse located in-line with the positive lead. Other accessories may use in-line fuses near the battery.**

## Typical Fuse Panel

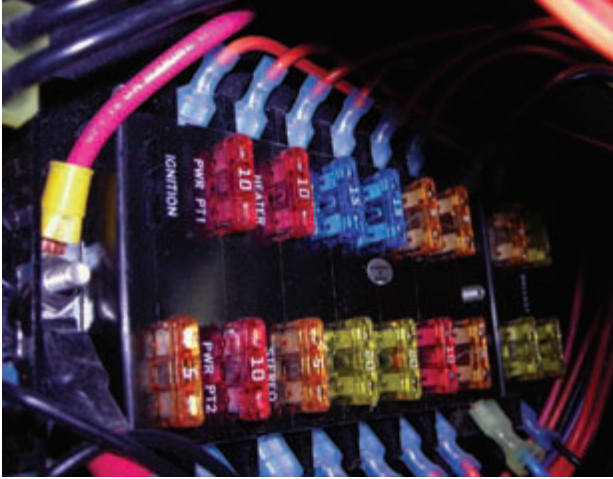

CNTRN-0004C-A

*Figure 11-4*

## Typical Breaker Panel



CNTRN-0031C-A

*Figure 11-5*

# CORROSION PROTECTION

## Hardware, Fasteners and Fittings

Check all fasteners, fittings, hinges, latches, rails and cleats for corrosion and tightness. Repair or replace any items that need attention. Never use automotive replacement parts when replacing marine parts.

Periodically clean all hardware with approved marine cleaners or mild soap and water. Never use abrasive cleaners or materials; they will scratch the polish and protective coatings on the hardware and cause the hardware to corrode. Applying a coating of marine-grade wax can help maintain the original shine of the hardware and help prevent corrosion.

## Stainless Steel and Chrome Hardware

Stainless steel and chrome will normally oxidize over time, especially in marine environments. Cleaning and preventative maintenance of stainless steel and chrome hardware are crucial in maintaining appearance and functionality. If the hardware is left unattended it can corrode causing the hardware to appear unsightly and cause structural integrity problems.

When operating the boat in corrosive environments such as salt water, the stainless steel and chrome hardware should be washed with mild soap and water after each use.

Remove rust or corrosion promptly by cleaning the hardware using a high-quality stainless steel, chrome cleaner or conditioner. Do not use any abrasive materials such as steel wool or sandpaper to clean the hardware. Do not use acids or bleach or any cleaners not intended for stainless steel or chrome, such as glass, tile or counter cleaners, as these types of cleaners can cause permanent damage. Always test a cleaner in an inconspicuous area first before applying to the complete surface.

After cleaning, protect the surface of the hardware by using a high-quality boat, automotive, stainless steel or chrome protectant or wax.

## Aluminum Hardware

Aluminum hardware should be washed periodically with soap and water to keep it clean. If the boat is used in salt water or polluted water, aluminum hardware should be washed with soap and water after each use. Salt water allowed to remain on aluminum will penetrate the metal and corrode the aluminum.

It is recommended to frequently clean and coat all aluminum hardware with a metal protectant made for aluminum to protect against pitting and corrosion caused by the harsh effects of salt water. Choose an appropriate cleaner specific to your needs, as special cleaners are available for different types of aluminum hardware such as anodized, powder-coated and polished.

## Galvanic Corrosion

Galvanic corrosion (electrolysis) is the deterioration of metals from the effects of electrolytic action. When two dissimilar metals are immersed in a conductive fluid such as salt water, an electric current is produced, much like a battery. As current flows between the two metals, the softer or sacrificial metal deteriorates.

If you operate in salt, polluted or brackish waters, your boat should be equipped with a transom-mounted sacrificial zinc anode to prevent corrosion damage to other metal parts of your boat that are in contact with the water. Zinc anodes are self-sacrificing and are slowly eroded by electrolytic action. These anodes are important and require periodic inspection for deterioration. They should be replaced when less than 50% of their original size.

Most engines are equipped with one or more zinc anodes that require periodic inspection. See the *Engine Operator's Manual* for maintenance procedures.

Electronic cathode systems are designed to reduce the effects of electrolysis. Electronic cathode systems emit an electrical low-current charge into the water near the metal components' neutralizing electrolytic action. **NOTICE: DO NOT paint or coat zinc anodes or cathodes with any substance. Once covered, they do not provide protection from galvanic corrosion. Replace anodes if they have deteriorated 50% or more.**

## Salt Water Corrosion

Rinse the boat hull and deck with fresh water and wash immediately after using your boat in salt water. If the boat is used primarily in salt water, wax the hull monthly and apply corrosion inhibitor to all hardware. See the *Engine Operator's Manual* for the flushing procedure.

Flushing the freshwater engine cooling system is recommended when the engine has been used in salt, polluted or brackish waters. Flush the entire engine cooling system with fresh water for at least 5 minutes after use in these waters. Consult your local marine dealer for suitable flushing equipment.

## GENERAL MAINTENANCE AND CLEANING

### Marine Growth

If accelerated marine growth is a problem in your area, an antifouling bottom paint may be necessary to slow growth and prevent gelcoat damage. Before selecting a bottom paint, talk with other boaters and your local marine dealer to determine which product works best in your area. Many local variables can affect the selection of paint. Be sure to follow the paint manufacturer's directions exactly.

### Cleaning

Never allow any type of cleaning solution or cleaning material to come in contact with the water or be discharged into the water. The discharge of any type of debris or waste, including but not limited to, food, trash, garbage, oil, fuel, liquids and human waste is highly restricted if not unlawful in most waterways. You should never discharge anything into the water.

Periodic cleaning is the best way to keep your boat looking new. Regular washing and waxing keep dirt, algae and water deposits from building up and deteriorating the finish. Keeping your boat in "show room" condition means greater personal satisfaction and higher resale value. Special cleaning products are available from your local marine dealer.

### Hull

*NOTICE: Do not leave your boat in the water for extended periods of time. Extended mooring may cause hull surfaces to discolor and/or blister. Damage caused from this type of exposure is not covered under the Centurion boat warranty. If extended mooring is necessary, consider using a high-quality bottom paint for additional protection.*

When washing the boat, use a mild detergent with a warm water solution. Never use abrasive cleaners, solvents, ammonia or chlorine to clean gelcoat surfaces as these will damage the gelcoat surface. Special cleaners are available from your local marine dealer to remove marine growth and algae from the hull.

You should wax gelcoat surfaces at least twice a season. Special marine gelcoat waxes are available from your local marine dealer to prevent color fade and dirt adhesion. If the gelcoat has oxidized, chalked, dulled or faded from lack of proper maintenance, buffing may be necessary to bring back the shiny appearance. Hand buffing with #7 rubbing compound or power buffing with glazing compound #1 should quickly restore the surface; however, you should always seek certified assistance before attempting to restore your boat's finish.

## Upholstery

Regular washing with warm soapy water is sufficient to keep the upholstery in good condition. For additional information on cleaners and upholstery maintenance, see the Upholstery Care information in your *Owner's Information Kit*.

## Canvas Covers and Bimini Tops

Regular washing with warm soapy water is sufficient to keep the canvas and bimini top in good condition. For additional information on cleaners and maintenance, see the Sunbrella® Fabric Care information in your *Owner's Information Kit*.

## Carpet

Occasional vacuuming and washing with mild detergent and warm water or household carpet cleaners will keep the carpet clean. Thoroughly wash the detergent out of the carpet with clean water. Let the carpet dry in the sun to prevent any mildew or odor caused by moisture.

## Windshield

A clean windshield is important. Your boat is equipped with a glass windshield, which can be sufficiently cleaned with a nonabrasive glass cleaner and a soft cloth. Harsh detergents, solvents, chemicals or dry cloths used on any glass windshield can scratch the surface.

## Teak

Teak does not normally require refinishing, but should be cleaned occasionally with a teak cleaner that you can purchase at a local marine dealer. The best way to keep teak in top condition is to oil it regularly with teak oil. Follow the manufacturer's instructions and warnings carefully as some cleaners or oils may damage gelcoat, vinyl or aluminum. Avoid using steel wool pads when cleaning, only Scotch-Brite™ or similar nonmetallic pads are recommended. **NOTICE:** *Teak oils and sealers can be harmful to other materials. Always thoroughly remove any teak oil that comes in contact with vinyl, gelcoats, etc. Never varnish teak; the natural oils in the wood will cause poor adhesion.*

If a scratch develops, it can be repaired easily using fine-grade sandpaper (400 to 1000 grit). Use a tack cloth to clean sanding residue, and then apply a small amount of lemon oil. Let dry and wipe with a soft cloth.

## Bilge

A boat's bilge area accumulates oil and greasy dirt over a period of time and should be cleaned periodically. Consult your local marine dealer for recommendations on special bilge cleaning products and procedures.



## Bilge Pump

Periodically check the bilge pump(s) inlet screens and hoses for obstructions and debris. Foreign materials can clog the screen and hoses or become lodged in the bilge pump impeller, which can cause the pump to malfunction. Periodically check the operation of the bilge pump and float switch, if equipped. Inspect all wiring, clamps and hoses for tightness on a regular basis.

## Cockpit Heater

The marine heater must be drained completely for winter storage. When winterizing the engine cooling system, the heater must be included. See the *Marine Heater Operator's Manual* for further information.

## Ballast Tank System

The ballast tank system must be completely drained before long periods of non-use and if the boat is to be stored in freezing temperatures to prevent damage to the system.

- Remove the boat from the water and open the drain seacocks to completely drain the system of water.
- Operate the pump in the drain mode for three seconds and stop. Repeat the procedure for other tank(s).
- Remove the ballast tanks filter bowl(s) and allow the filter(s) to completely drain of water. Clean the ballast filter(s) and/or replace, then reinstall the filter bowl(s).
- Close the water drain seacocks.



CNTRN-0032C-A

**Figure 11-6**

## Trim Tab

Periodically inspect the trim tab for damage and leaks. Check the hydraulic pump (if equipped) fluid level periodically and fill with the recommended fluid.

## Switch Blade

Periodically inspect the Switch Blade for damage and loose parts. For additional maintenance information, see the *Switch Blade Operator's Manual* in the *Owner's Information Kit*.

## SAFETY EQUIPMENT

Periodically check the safety equipment for damage, general condition and operation when applicable. Always replace safety equipment that is in question or in need of repair:

- Fire extinguisher
- Life jackets
- Visual distress signaling devices
- Audible distress signaling devices
- Navigational lights
- Emergency radios or Emergency Position Indicating Radio Beacon (EPIRB)
- First aid kit

# GENERAL BOATING EQUIPMENT

Periodically check the general equipment on-board for damage, general condition and operation when applicable. Always replace equipment that is in question or in need of repair.

- Anchors and anchor lines
- Boat hook
- Dock fenders
- Foul weather gear/clothing
- Mooring lines
- Oars/paddles
- Tool kit
- Tow line

## TRAILER

Periodically check the general trailer components for damage, general condition and operation when applicable. Always replace trailer components that are in question or in need of repair.

- Lights
- Electrical connectors
- Tires (condition and pressure)
- Wheel lug nuts and studs
- Wheel valve stems
- Wheel bearings
- License plate and holder
- Rollers, bunks and hardware
- General fasteners (missing, loose or corroded)
- Safety chains or straps
- Winch, winch strap and hooks
- Trailer coupler and latch
- Frame, axle and springs
- Spare tire and wheel
- Brakes and actuator assembly

## Section 12

# WINTERIZATION AND STORAGE

Your boat may be equipped with a variety of specialized systems and components. The following basic and typical information may not apply to your specific application. This section may not cover all systems or components on your boat. Consult your local marina or certified marine technician for assistance.

Winterizing or storing your boat for extended periods of non-use requires special preparation to prevent boat and system damage. Without proper preparation, if your boat is not used or is stored for extended periods of time, internal parts of the engine may become corroded from lack of lubrication. If your boat is stored in freezing temperatures, water inside the bilge, engine cooling system or boat water systems may freeze and cause damage. Be sure to keep up with all annual maintenance during winterization.

## WINTERIZATION AND STORAGE PREPARATION

The following procedures should help prevent damage to your boat:

- While the boat is still in the water, fill fuel tank(s) with fresh fuel and add the proper amount of fuel stabilizer/conditioner according to the engine manufacturer's recommendations. Operate the boat for at least 15 minutes to ensure that the treated fuel has reached the engine. *NOTICE: If you plan to store your boat for more than 3 months in either a humid environment, extreme temperatures or outdoors, "fog" the engine with a corrosion-preventing fogging oil according to the engine manufacturer's recommendations. See the Engine Operator's Manual for more information.*
- Once the boat is removed from the water, remove the bilge drain plug immediately. Store the drain plug in a plastic bag and tape it to the throttle control lever for easy accessibility the next time you use your boat.
- Inspect all sacrificial corrosion protection anodes for excessive wear and replace as necessary.
- Check all thru-hull fittings and other fasteners for tightness and leakage.
- Thoroughly clean the hull, deck and interior of the boat as soon as you remove it from the water; marine growth is easier to remove when it is wet.
- Always allow all boat compartments to air dry for a couple of days to prevent mildew from trapped moisture. If you use shrink wrap, always allow for ventilation to prevent mildew from trapped moisture.

- Apply a coat of wax to the entire surface of the boat and rust inhibitor on all metal parts.
- Clean all traces of dirt, oil, grime and grease from the engine and bilge.
- After washing, raise the bow of the boat high to allow as much water as possible to drain while performing other storage preparations.
- Prepare the engine for storage according to the *Engine Operator's Manual*.
- Perform all scheduled maintenance for the engine and boat equipment. See the *Engine Operator's Manual* and all equipment manufacturer's information for periodic and annual maintenance procedures.
- Turn off all electrical switches and breakers.
- Remove all batteries from the boat. Clean, fully charge and store the batteries in an area outside the boat not subject to freezing temperatures. Never store batteries close to heat, sparks or open flames. Do not store batteries on cement or concrete surfaces.
- Open all water drains and seacocks, and thoroughly drain all ballast tanks (if equipped) and water lines. Manually disconnect any lines that may have residual water trapped.
- Thoroughly drain all ballast tank filters (if equipped) that may have residual water trapped.
- Thoroughly drain the interior heater core and lines (if equipped). Manually disconnect any lines that may have residual water trapped. See the *Heater Operator's Manual* for specific storage information.
- Clean all interior upholstery, furniture and carpet.
- The use of pest or rodent repellents may help prevent damage to your boat during storage.

## STORING ON A CRADLE OR BLOCKS

- When storing a boat on support other than the proper trailer, make sure the hull is supported properly to prevent damage. Most cradles are custom-built to support the boat's hull.
- The cradle or blocks should be on a hard, level surface capable of supporting the combined weight of the cradle and the boat.
- When using blocks with jack stands, always use jack stands that are rated for more than the required load, making sure they are securely positioned so they cannot move under the load. Use a minimum of three blocks to support the keel and each side of the boat where applicable. Use a minimum total of nine jacks and/or blocks.
- Position the boat to allow for adequate draining from rain or snow.
- Cover the boat to prevent the collection of rain, snow or debris. When using a cover, allow ventilation for residual moisture and condensation to escape. Never cover or plug the boat bilge drain hole.

## STORING ON A TRAILER

- Ensure the trailer supports are adjusted to properly support the boat's hull.
- Repack the trailer wheel bearings with water-resistant wheel bearing grease.
- Park the trailer and boat in a protected area, to reduce possible damage from the elements and surroundings.
- Loosen the tie-downs and winch line and ensure the boat is resting properly on hull supports.
- Lift the trailer and place blocks under the trailer frame to relieve weight on trailer tires and springs. Position the boat to allow for adequate draining from rain or snow.
- Cover the boat to prevent the collection of rain, snow or debris. When using a cover, allow ventilation for residual moisture and condensation to escape. Never cover or plug the boat bilge drain hole.

## RECOMMISSIONING AFTER STORAGE

- Remove blocks from under the trailer frame.
- Tighten tie-downs and the trailer winch line.
- Check tire pressure and lug nut tightness on the trailer.
- Inspect the hull for damage.
- Charge and install all batteries.
- Check the bilge blower vents for obstructions and blower operation.
- Check the bilge pump and float switch for proper operation.
- Inspect all battery and electrical wiring for loose connections and/or damage.
- Check the fuel system for leaks or damage.
- Check the engine and bilge for signs of nesting animals; clean as necessary.
- Check entire engine for cracks and leaks caused by freeze damage.
- Check the condition of all hoses and clamps for tightness.
- Clean the bilge area and install the boat bilge drain plug.
- Lubricate all seacocks and check for proper operation.
- Install all drain plugs in strainers and seacocks.
- Close all drains and valves that were opened during winterization.
- Perform any annual maintenance not performed during winterization. See the *Engine Operator's Manual* and all equipment manufacturers' information for periodic and annual maintenance procedures.
- Check the engine's cooling water intake areas and screens (if equipped) for obstructions.
- If the engine uses a self-contained cooling system and was drained for storage, fill the system with fresh coolant solution. Check the *Engine Operator's Manual* for specific procedures.
- Check all engine exhaust connections for exhaust leakage or damage.
- Check and lubricate the steering system.
- Check all navigational lights.

## Section 12

- Check all controls, gauges, boat systems, accessories and related equipment for proper operation.
- Check all fire extinguishers for charge level.
- Inspect all safety equipment for condition and operation as applicable.
- When possible, briefly start and run the engine(s) using proper water supply equipment to check that the engine does start and there are no major operational problems. *NOTICE: If fogging oil was used during winterization, the engine will emit excessive white smoke upon initial start-up. This condition is normal and will diminish once the fogging oil has been cleared through the engine.*
- Once the boat is in the water, start the engine.
- When the engine starts, watch gauge readings closely, checking for leaks and abnormal noises.
- Keep speeds low for the first 15 minutes until the engine has reached normal operating temperature.
- See the *Engine Operator's Manual* and all equipment manufacturers' information for additional recommendations.

## LIFTING

Only qualified and experienced persons should attempt to lift or hoist boats. This procedure requires special equipment and experience. Do not attempt to lift or hoist your boat alone; damage, personal injury or death can occur. **WARNING!** *There are several lifting hazards you should be aware of if you need to lift the boat and/or engine. See Safety Precautions in the Safety section of this manual for more details.*

If the boat is to be removed from the water without a trailer, follow these guidelines:

- Cover lifting cables with a rubber hose or other protectors to prevent damage to the finish.
- Attach guidelines to the bow and stern to control movement.
- Use spreader bars and keep lifting pressure vertical to prevent side load damage.
- Keep the bow slightly higher than the stern to prevent engine damage.

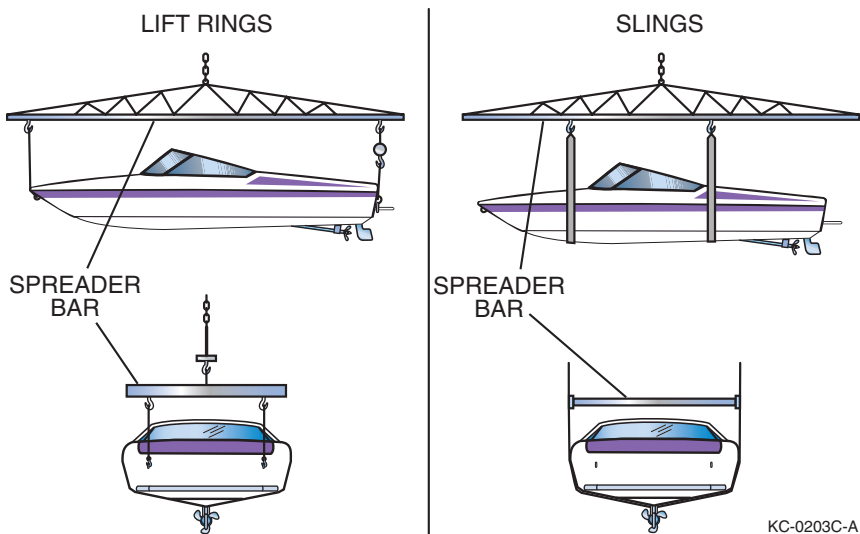

**Figure 12-1**



**This Page Intentionally Left Blank**

Section 13

# TROUBLESHOOTING

The following information will assist you in identifying basic performance, mechanical and electrical problems. This information is intended as a general troubleshooting guide and may describe items that are not applicable to your boat.

If you detect a problem with the engine, see the *Engine Operator's Manual*. If you detect an equipment or boat system problem, see the manufacturer's information for that item.

Before performing any troubleshooting procedures within this section, see Safety on page 3-1. **NOTICE:** *Certain problems may require specialized skills and tools. Always consult qualified personnel before making any repairs or modifications.*

Problem	Possible Causes
Engine will not crank.	<ul style="list-style-type: none"> <li>• Engine emergency stop switch lanyard not connected</li> <li>• Shift/throttle control not in the NEUTRAL position</li> <li>• Main circuit breaker open</li> <li>• Battery switch is in the OFF position.</li> <li>• Battery terminals or wiring connections corroded</li> <li>• Low battery voltage</li> <li>• Faulty ignition switch</li> <li>• Engine problem</li> </ul>
Engine cranks but will not start.	<ul style="list-style-type: none"> <li>• No fuel in tank</li> <li>• Fuel tank valves closed to engine</li> <li>• Fuel filter clogged</li> <li>• Flame arrestor dirty, if equipped</li> <li>• Contaminated fuel</li> <li>• Engine problem</li> </ul>

## Section 13

Problem	Possible Causes
Poor boat performance	<ul style="list-style-type: none"><li>• Contaminated fuel</li><li>• Uneven load distribution</li><li>• Excessive load</li><li>• Improper trim equipment position (if equipped)</li><li>• Improper propeller selection</li><li>• Excessive water in bilge</li><li>• Damaged or obstructed propeller</li><li>• Marine growth on hull</li><li>• Damaged hull</li><li>• Engine system problem</li><li>• Plugged flame arrestor (if equipped)</li></ul>
Throttle/shifting control problems	<ul style="list-style-type: none"><li>• Corroded cable</li><li>• Excessive bends or kinks in cable</li><li>• Engine system problem</li></ul>
Excessive vibration	<ul style="list-style-type: none"><li>• Damaged or obstructed propeller</li><li>• Bent propeller shaft</li><li>• Engine system problem</li></ul>
Electrical problems	<ul style="list-style-type: none"><li>• Blown fuse/breaker or open circuit</li><li>• Loose or corroded wiring connections</li><li>• Defective switch or gauge</li><li>• Weak or discharged battery</li></ul>
Erratic or no speedometer reading	<ul style="list-style-type: none"><li>• Disconnected, kinked or plugged pickup tube or pitot (if equipped)</li><li>• Faulty speedometer paddle wheel or connection</li><li>• Faulty speedometer gauge</li></ul>

## **GLOSSARY OF NAUTICAL TERMS**

**ABOARD** – On or in the boat.

**ABYC** – American Boat and Yacht Council, Inc.

**AFLOAT** – On the water.

**AFT** – Toward the rear or stern of the boat.

**AGROUND** – Touching bottom.

**AMIDSHIP**– Center or middle of the boat.

**ANCHOR** – (1) An iron casting shaped to grip the lake bottom to hold the boat. (2) The act of setting the anchor.

**ASHORE** – On the shore.

**ASTERN** – Toward the stern.

**BAIL** – To remove water from the bottom of the boat with a pump, bucket, sponge, etc.

**BEAM** – The widest point on the boat.

**BEARING** – Relative position or direction of an object from the boat.

**BILGE** – The lowest interior section of the boat hull.

**BOARDING** – To enter the boat.

**BOUNDARY WATERS** – A body of water between two areas of jurisdiction; i.e., a river between two states.

**BOW** – The front of the boat.

**BULKHEAD** – Vertical partition (wall) in a boat.

**BUNKS** – Carpeted trailer hull supports.

**BURDENED BOAT** – Term for the boat that must “give-way” to boats with the right-of-way.

## Section 14

**CAPACITY PLATE** – A plate that provides maximum weight capacity and engine horsepower rating information. It is located in full view of the helm.

**CAPSIZE** – To turn over.

**CAST-OFF** – To unfasten mooring lines in preparation for departure.

**CENTER LINE** – A lengthwise imaginary line which runs fore and aft with the boat's keel.

**CHINE** – The point on a boat where the side intersects (meets) the bottom.

**CLEAT** – A deck fitting with ears to which lines are fastened.

**CONSOLE** – Also called helm. The steering wheel area of the boat.

**CRANKING BATTERY** – The main battery used for engine starting and electrical circuits.

**CURRENT** – Water moving in a horizontal direction.

**DECK** – The open surface on the boat where the passengers walk.

**DEEP-CYCLE BATTERIES** – Special long-running batteries which can be repeatedly discharged and recharged without significant loss of power.

**DOLLY WHEEL** – A rolling jack assembly at the front of the trailer used for positioning the coupler during trailer hookup.

**DRAFT** – The depth of the boat below the waterline, measured vertically to the lowest part of the hull.

**ELECTROLYSIS** – The breakup of metals due to the effects of galvanic corrosion.

**FATHOM** – Unit of depth or measure; 1 fathom equals 6 feet.

**FENDERS** – Objects placed alongside the boat for cushioning. Sometimes called bumpers.

**FORE** – Toward the front or bow of the boat. Opposite of aft.

**FREEBOARD** – The distance from the water to the gunwale.

**FUEL SENDING UNIT** – The electrical device that is mounted on the outside of a built-in fuel tank and controls the dashboard fuel gauge.

**GIVE-WAY BOAT** – (1) Term for the boat that must take whatever action necessary to keep well clear of the boat with the right-of-way in meeting or crossing situations. (2) The burdened boat.

**GUNWALE** – The rail or upper edge of a boat's side.

**HELM** – The steering wheel or command area.

**HULL** – The body of the boat.

**HYPOTHERMIA** – A physical condition where the body loses heat faster than it can produce it.

**IN-LINE FUSE** – A type of protective fuse located in the power wire of a direct current (DC) circuit usually near the battery.

**KEEL** – The lowest portion of the boat; extends fore and aft along the boat's bottom.

**LIFE JACKET**– A buoyant wearable jacket that when properly used, will support a person in the water, also see PFD.

**LIST** – Leaning or tilt of a boat toward the side.

**MAKING WAY** – Making progress through the water.

**MARINE CHART** – Seagoing maps showing depths, buoys, navigation aids, etc.

**MOORING** – An anchor, chain or similar device that holds a boat in one location.

**NAVIGATION AID** – Recognizable objects on land or sea such as buoys, towers or lights which are used to fix position to identify safe and unsafe waters.

**NMMA** – National Marine Manufacturers Association.

**NO-WAKE SPEED** – The speed at which a boat travels to produce an imperceptible wake.

**PFD** – A buoyant personal flotation device used to support a person in the water, also see Life Jacket.

**PLANING HULL** – A hull designed to lift, thereby reducing friction and increasing efficiency.

**PORPOISE** – A condition in which the bow bounces up and down.

**PORT** – (1) The left side of a boat when facing the bow. (2) A destination or harbor.

**PRIVILEGED BOAT** – Term used for the boat with the right-of-way.

**RIGHT-OF-WAY** – Term for the boat that has priority in meeting or crossing situations. The stand-on or privileged boat.

**RULES OF THE ROAD** – Regulations for preventing collisions on the water.

**SEACOCK** – A thru-hull valve or shut off on a plumbing or drain pipe between the vessel's interior and the sea.

## Section 14

**STAND ON BOAT** – Term for the boat that must maintain course and speed in meeting or crossing situations. The privileged boat.

**STARBOARD** – The right side of the boat when looking toward the bow.

**STERN** – The back of the boat.

**STOW** – To pack the cargo.

**SURGE BRAKES** – A type of trailer braking system designed to automatically actuate when the tow vehicle's brakes are applied.

**TRANSDUCER** – The unit that sends/receives signals for the depth sounder.

**TRANSOM** – The transverse beam across the stern.

**TRIM** – Fore-to-aft and side-to-side balance of the boat when loaded.

**UNDER WAY** – Boat in motion; i.e., not moored or anchored.

**USCG** – United States Coast Guard.

**WAKE** – The waves that a boat leaves behind when moving through the water.

**WATERWAY** – A navigable body of water.

**V-PAD** – A modified vee-hull design with a small, flat area in the keel aft.

**VISUAL DISTRESS SIGNAL** – A device used to signal the need for assistance such as flags, lights and flares.



## Notes





## Notes



# CENTURION

Fineline Industries West  
2047 Grogan Avenue  
Merced, CA 95340  
209-384-0255

Fineline Industries East  
P. O. Box C  
Woodland, NC 27897  
252-587-0405

[www.centurionboats.com](http://www.centurionboats.com)

Part No. OM-07

Printed in U.S.A.